

Spark[®] Cyto.

MULTIMODE PLATE READER WITH LIVE-CELL IMAGING
AND REAL-TIME CYTOMETRY

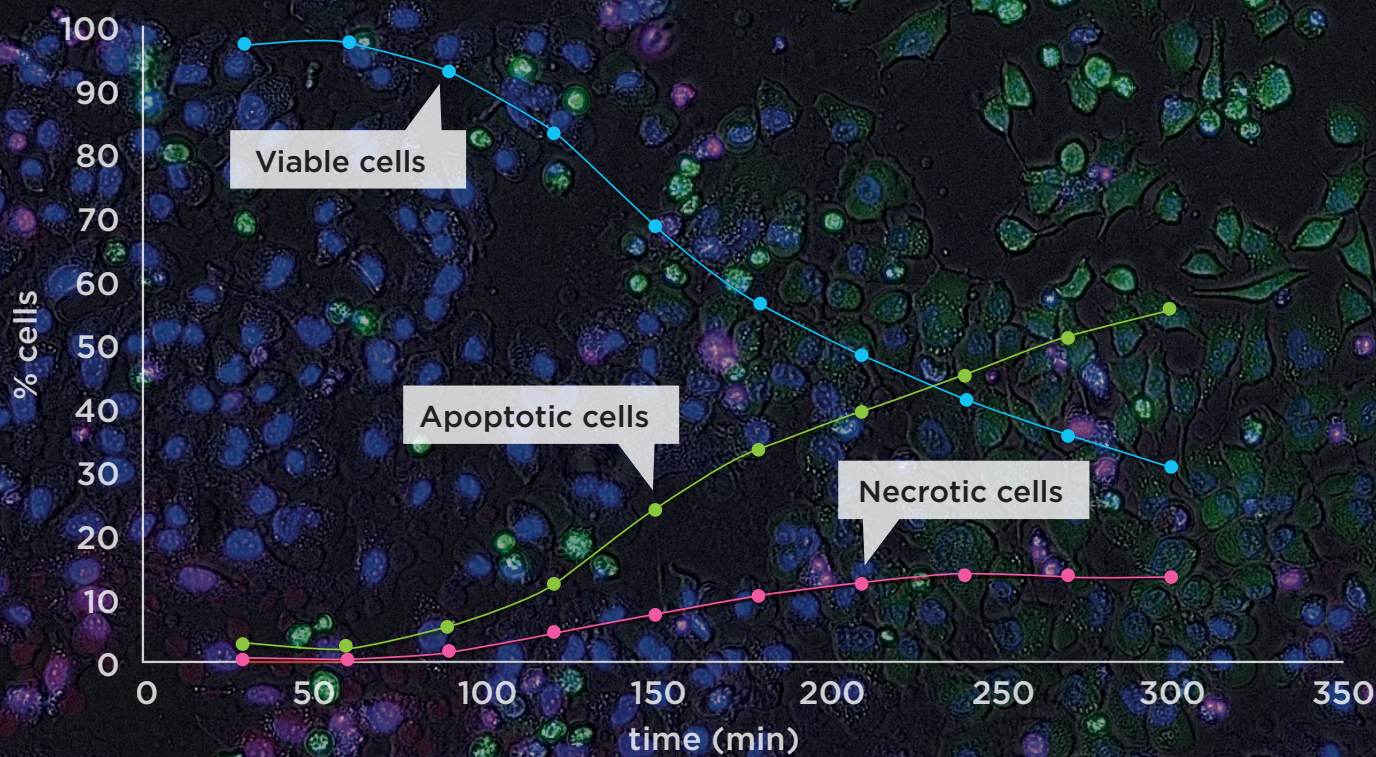

Life happens in real time.



Spark Cyto is a multimode plate reader combining bright field and fluorescence imaging with industry-leading detection technologies to enable real time image cytometry, unlocking new possibilities for your cell-based research.

Your cells don't stay static when you leave the lab, so your research requires a dynamic instrument that ensures you never miss a critical biological event. Spark Cyto works in real time with integrated cell incubation capabilities, and uses parallel data acquisition and analysis to deliver meaningful insights for cell-based assays.

With Spark Cyto, you now have the ability to unite qualitative and quantitative information into unique multiparameter data sets faster than before.

More insights delivered in real time, and more cells analyzed

Spark Cyto brings together a unique combination of patent-pending technologies to ensure you can truly investigate your entire cell population. It gives you the ability to record the whole well area of a 96- or 384-well microplate with just one image - no tiling or distortion - meaning you never miss a cell.

Objective	NA	Pixel resolution	Optical resolution	Field of view (mm)
2x	0.08	3.45 μm	4.50 μm	8.47 x 7.09
4x	0.13	1.72 μm	2.77 μm	4.24 x 3.54
10x	0.30	0.69 μm	1.20 μm	1.69 x 1.42

A dedicated optical set-up for live-cell cytometry in microplates, from 6- to 384-well formats

Using three objectives, five LEDs (bright field and fluorescence excitation), a multiband filter set and a CMOS camera, Spark Cyto eliminates pixel shifts and delivers high quality images in a flash.

Spark Cyto combines three magnification levels with four channels for fluorescence and bright field imaging, enabling high quality cell analysis for a wide range of applications.

Color	Excitation (nm)	Emission (nm)
Blue	381-400	414-450
Green	461-487	500-530
Red	543-566	580-611
Far red	626-644	661-800

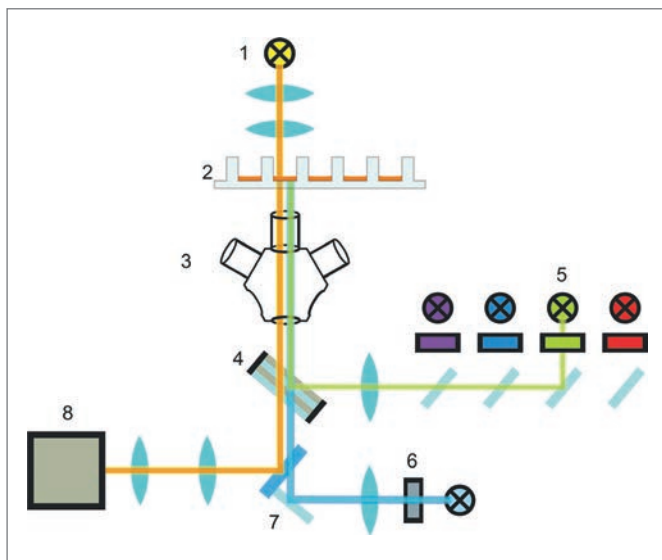

Schematic diagram of imager module. (1) LED for bright field; (2) microplate with sample; (3) objective; (4) multiband filter set; (5) LEDs and excitation filters for fluorescence; (6) autofocus unit; (7) reflection mirror; (8) CMOS camera.

Autofocus enabled - stay focused on your research

Spark Cyto uses a patented LED-based autofocus system to deliver high quality images while offering uncompromised speed for scanning. The autofocus system projects an extended grid pattern onto the sample surface, which minimizes the impact of potential distortions from isolated impurities. This fast, simple and effective autofocus comes as standard on every instrument, so you'll never miss an image.

Auto-exposure - fast and easy image optimization

Setting the optimal exposure time for images with a wide range of signal intensities can be a laborious process. The auto-exposure function in Spark Cyto's live viewer automates the optimization of exposure settings, creating an ideal balance and minimizing under- and overexposure of cellular signals.

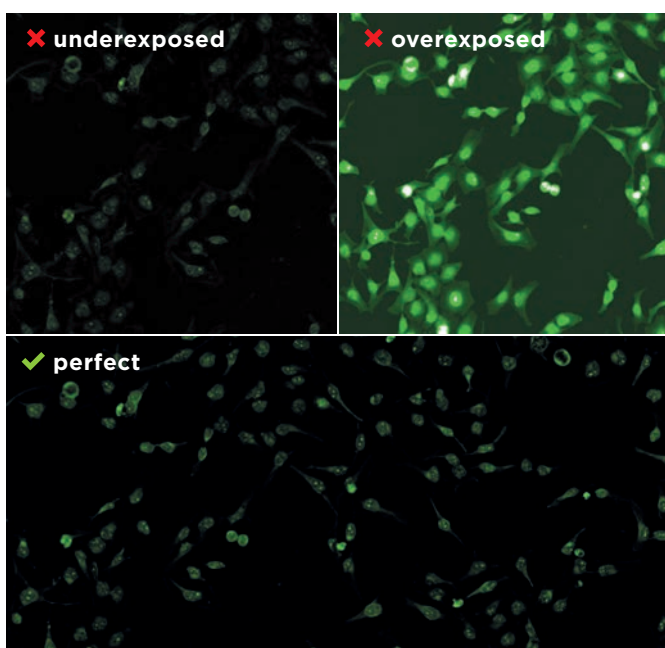

The auto-exposure function helps to capture optimal images of all your cells without lengthy optimization steps.

One single image can tell the whole story

Spark Cyto captures the whole well (96- and 384-well plates) with a single image, giving you a real picture of your research.

It is based on a proprietary patented approach where image acquisition with the 2x (96-well plates) and 4x (384-well plates) objective is combined with a large camera chip and advanced imaging algorithms to give you accurate results.



Single image of an entire well from a 96-well plate. No tiling or edge-to-edge optical distortion leads to superior results when analyzing cell populations.

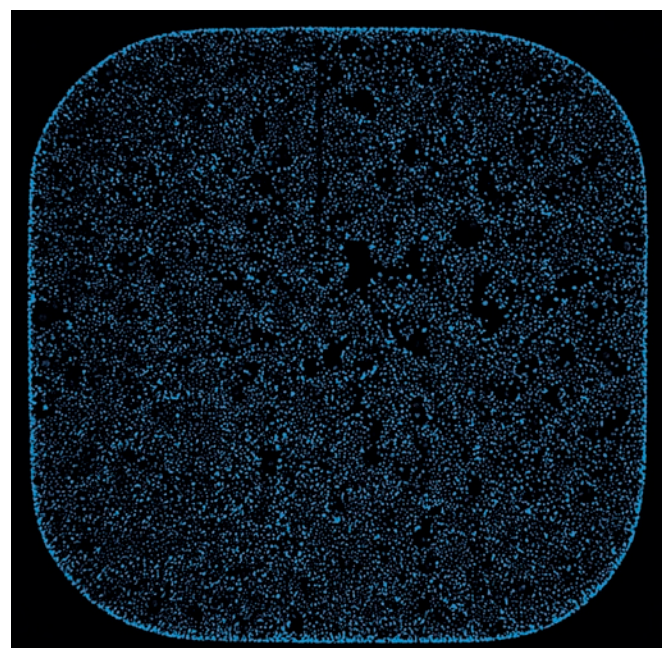

Whole well imaging in 384-well plates enables fast and accurate nuclei counting of cells stained with Hoechst 33342.

Applications.

Predefined applications for the most common cytometric assays:

- label-free cell counting
- confluence
- nuclei counting
- transfection efficiency
- cell viability
- cell death

Label-free cell counting

This feature offers a fast and reliable way to count cells in bright field images directly, without the need of cellular dyes. Using a deep learning algorithm, a yellow cross is overlaid on identified cells for easy visualization, and the total cell count is displayed for each well.

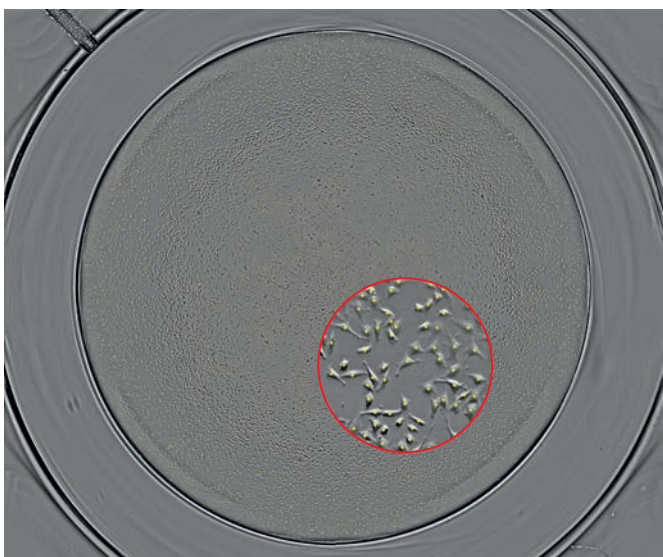

Whole well image of a 96-well plate showing HeLa cells with bright field cell counting yellow overlay, acquired with the 4x objective.

Confluence

Use the bright field imaging channel to provide a quick overview of a well's cell density. Cell confluence is calculated automatically by the software, and displayed as a yellow overlay for easy visual confirmation. In addition, you can use the roughness factor as a simple indicator of cell death.

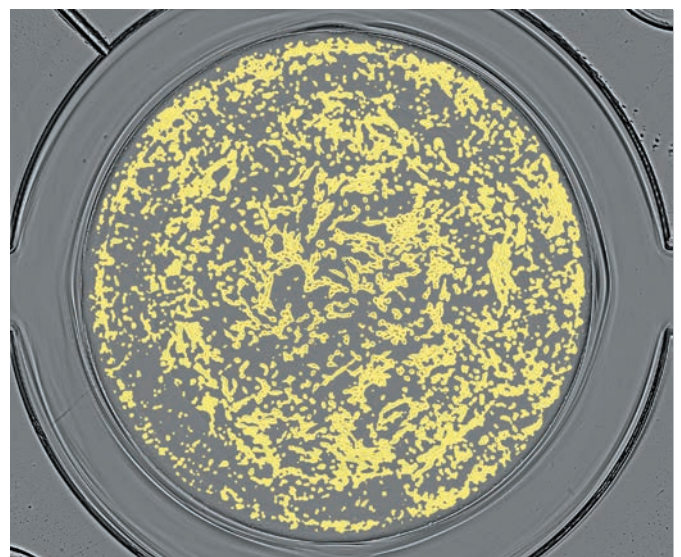

Whole well image from a 96-well plate, acquired with the 2x objective, showing NHDF cells with confluence evaluation mask.

Nuclei counting

Optimized for Hoechst 33342, this function provides an easy method for cell counting using any blue fluorescent dye with nuclear DNA binding capabilities.

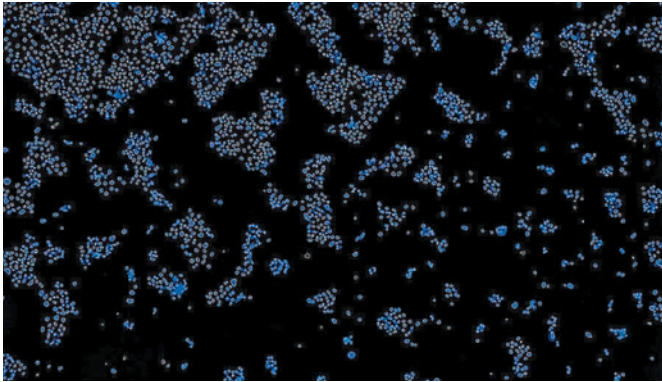

Whole well image from a 384-well plate, acquired with the 4x objective, showing CHO cells with nuclei counting mask.

Transfection efficiency

This feature can automatically determine transfection rates for cells containing green fluorescent protein (GFP) - a widely used reporter for gene expression - and counter-stained with Hoechst 33342 (blue). The green and blue images are overlaid and analyzed to determine the transfection efficiency in the cell population.

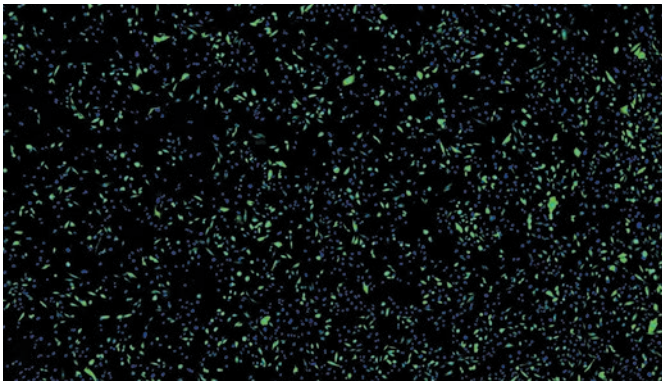

Centered image of CHO cells cultured in a 96-well plate, acquired with the 4x objective, showing an overlay of the blue and green channels.

Cell viability

Spark Cyto's preset cell viability application relies on a common double staining approach to discriminate between live (green) and dead (red) cells in a population. Using two fluorescent dyes, such as calcein AM (live cells) and propidium iodide (dead cells), you can image and analyze your population in minutes.

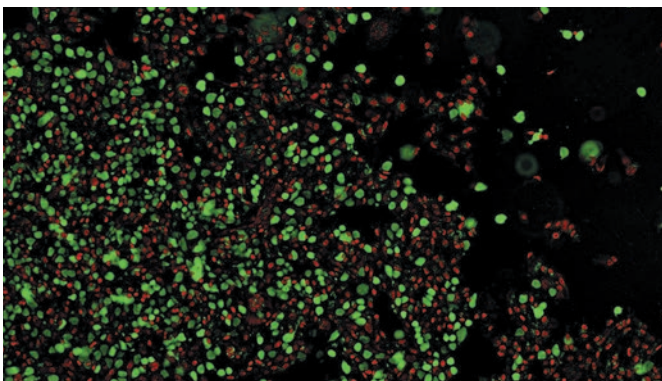

Centered image of HeLa cells cultured in a 24-well plate, acquired with the 10x objective, showing an overlay of the bright field, green and red channels.

Cell death

Spark Cyto can detect cell death, and discriminate between apoptosis and necrosis, using differential staining:

- **Hoechst 33342 (blue)** - nuclear stain
- **Propidium iodide (red)** - necrotic cell stain
- **Annexin V-FITC / Alexa Fluor® 488 (green)** - binds to the early apoptosis marker phosphatidylserine

Using a proprietary algorithm, the software can uniquely identify three object classes:

- Blue objects - cell nuclei
- Blue/red objects - necrotic cells (for live:dead cell ratio)
- Blue/red/green objects - apoptotic cells (for apoptotic:necrotic cell ratio)

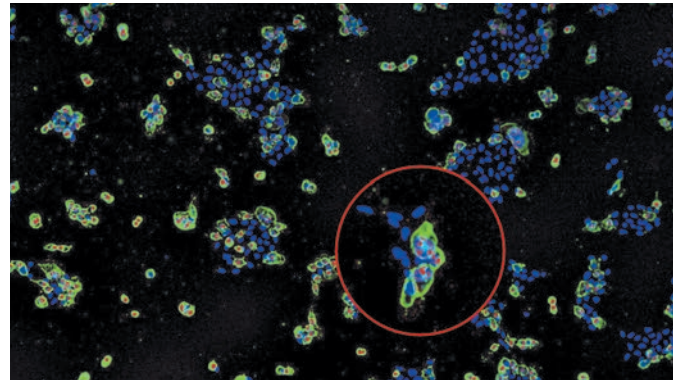
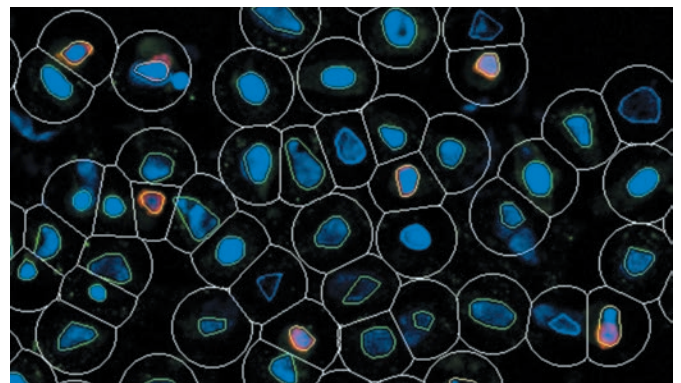

Image of A431 cells cultured in a 96-well plate, acquired with the 10x objective, showing an overlay of the blue, green and red channels.

Multi-Color analysis

Spark Cyto's easy-to-use Multi-color application is ideal for counting and analyzing cells with multiple labels. A fluorescent marker for nuclei, and up to two additional labels, are automatically analyzed to characterize your cells.



HeLa cells cultured in a 96-well plate, acquired with the 10x objective. Cells have been treated with a low dose of demecolcine, stained with Hoechst 33342 to visualise the nuclei, and labelled with anti-alpha-tubulin (Alexa Fluor 488) and anti-phospho-histone H3 (Alexa Fluor 647).

Never miss a critical biological event.

Automation of live-cell experiments with Real Time Experimental Control (REC™)

REC grants you the ability to create novel experimental workflows and unlock new research possibilities for multiplexed data. The system combines standard detection technologies and imaging capabilities with proprietary software to enable kinetic experiments to be performed automatically. For example, the system can inject a reagent or start a fluorescence measurement once a user-defined population status or signal threshold is reached, such as a confluence of 80 percent.

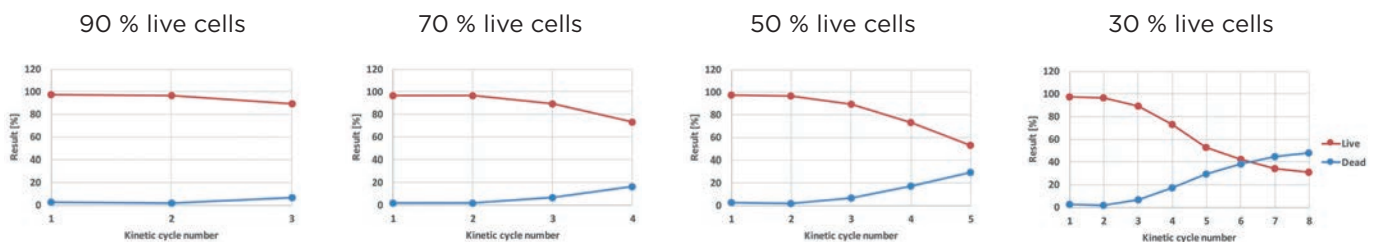
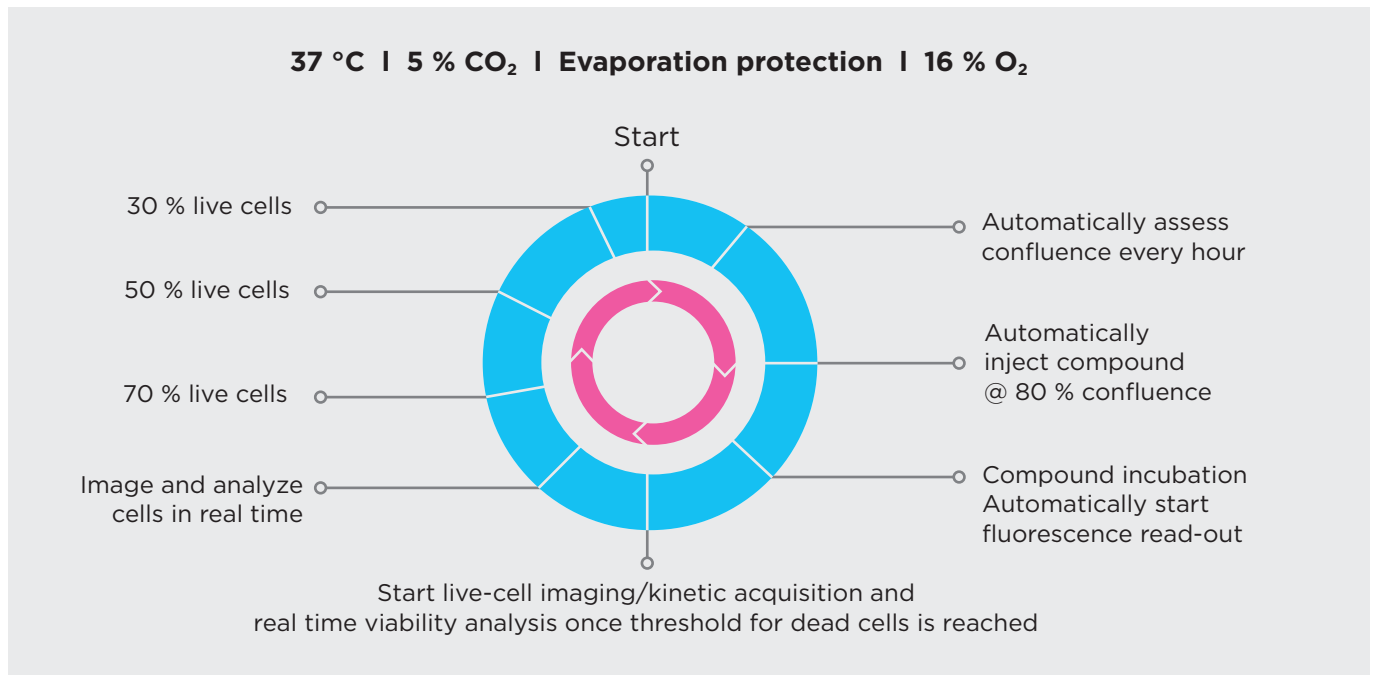

Automatic kinetic measurements for live/dead cells with an interval of 2 h over a time period of ca. 20 h.

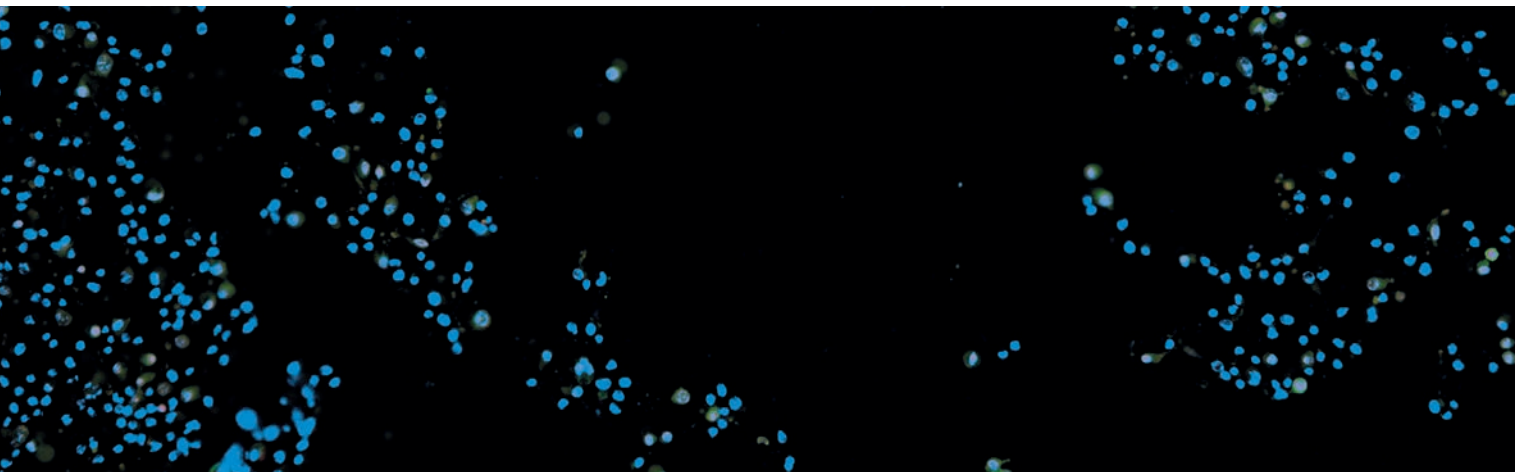

Complete environmental control comes as standard

Spark Cyto is equipped with a unique environmental control system that allows you to maintain a stable environment for your assays, effectively eliminating the risk that temperature fluctuations or evaporation could pose to your results. Spark Cyto is the only instrument to put these features right at your fingertips:

- Uniform temperature control (up to 42 °C)
- Dynamic gas control (CO₂ and O₂)
- Humidity control via patented Lid Lifter™ and Humidity Cassette

Lid Lifter

Spark's integrated and patented lid-lifting function establishes an ideal environment for long-term kinetic assays and reduces the risk of sample contamination. Whether you want to dispense reagents without the need for manual intervention or maintain optimal environmental conditions without compromising evaporation protection, Spark Cyto is the only reader to offer this benefit.

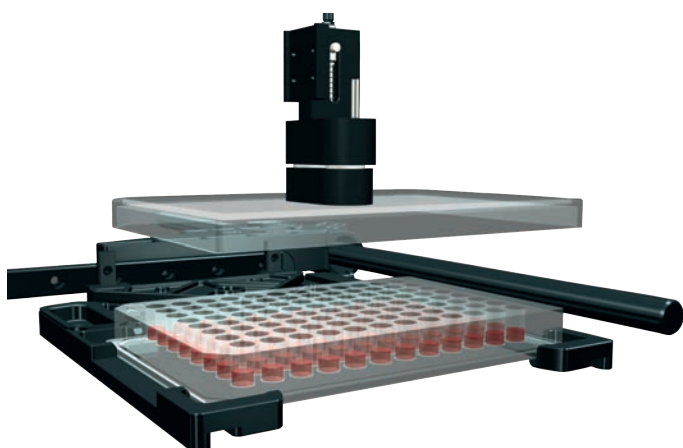

Humidity control for optimal evaporation protection

Maintaining humidity levels of 95 percent or higher is essential for unimpaired cell viability and growth, and minimizing evaporation is essential for maintaining consistent concentrations during long-term assays. Spark's patented Humidity Cassette is a cost-effective solution to minimize evaporation.

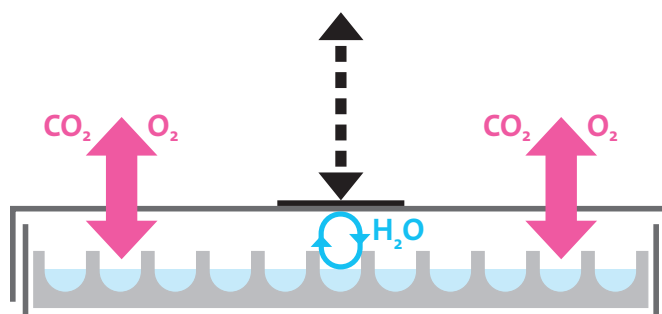

More parameters measured

The system's Method Editor offers unique options for researchers looking to customize their assays:

- **User-defined protocols** – for automated image acquisition and analysis
- **Imaging only** – allowing acquisition and export of files to any third-party image analysis software, such as ImageJ or CellProfiler

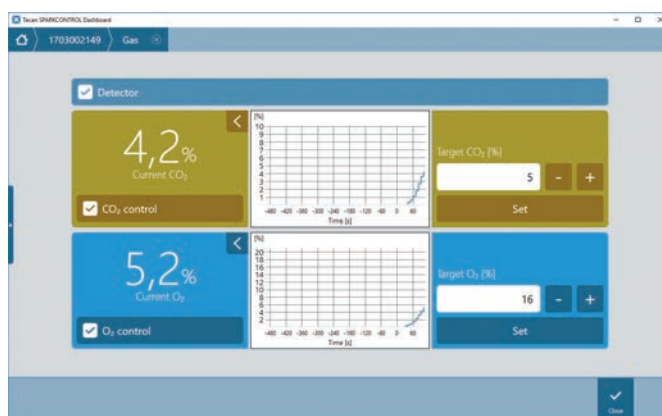

You have full control of the environmental conditions during a run, including the temperature and the CO₂ and O₂ levels inside the reader.

Configurations

to meet your applications.

No matter the configuration of your Spark Cyto, you have a fully equipped system ready for live-cell imaging cytometry.

Capabilities Spark Cyto	100	300	400	500	600
Fluorescence Imaging	•	•	•	•	•
Brightfield imaging	•	•	•	•	•
Digital phase contrast imaging	•	•	•	•	•
Absorbance UV/vis monochromator - STD 384		•	•		
Absorbance UV/vis monochromator - ENH 1536				•	•
Fluorescence - STD 384		•			
Fluorescence - ENH 1536			•	•	•
Fluorescence filter top/bottom		•		•	
Fluorescence monochromator top/bottom			•		
Fluorescence Fusion Optics top/bottom					•
Fluorescence variable bandwidth			•		•
Fluorescence polarization			•	•	•
Fluorescence dichroic mirrors			•	•	•
Luminescence - STD 384 / multi-color and scanning		•	•		
Luminescence - ENH 1536 / multi-color and scanning				•	•
Alpha technology					•
Lid Lifter™	•	•	•	•	•
Heating	•	•	•	•	•
CO ₂ control	•	•	•	•	•
O ₂ control	•	•	•	•	•

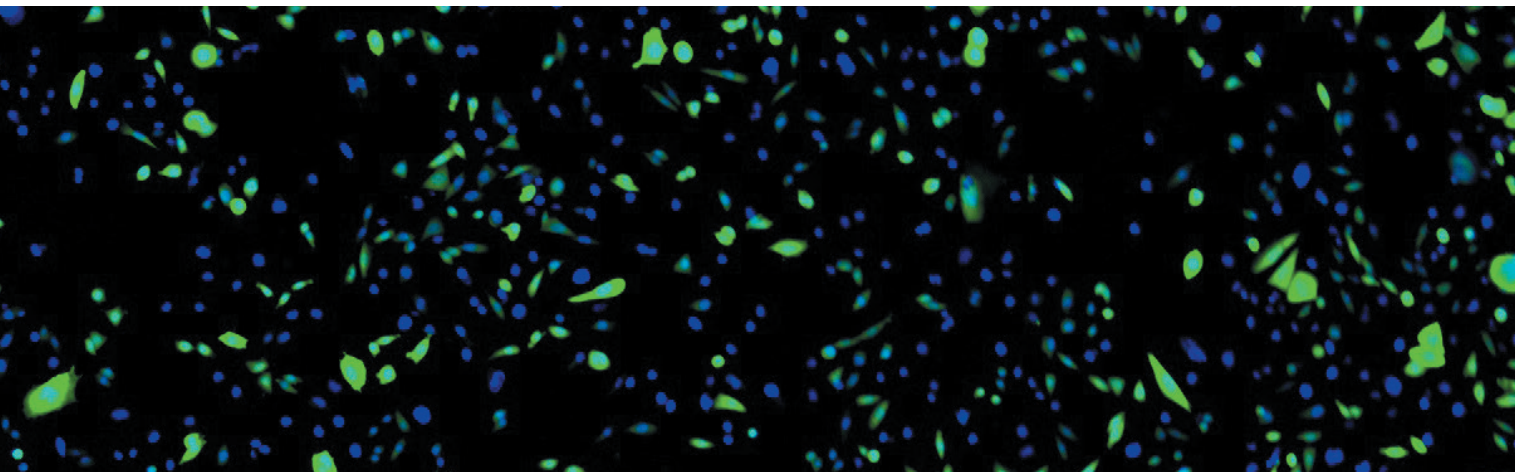

Spark Cyto sets a new standard for fluorescence imaging microplate readers by offering the following features with every configuration:

- Lid Lifter
- Integrated gas control (CO₂/O₂)
- Heating
- LED-based autofocus
- Objectives (2x, 4x, 10x)
- 5-LED excitation, 4 color channels
- Digital phase contrast
- SparkControl™ software
- ImageAnalyzer™ software
- Instrument control unit



The NanoQuant Plate allows parallel quantification and analysis of up to 16 nucleic acid or protein samples, in volumes as little as 2 µl.

All four configurations can be equipped with additional options:

- Reagent dispensers with heating and stirring
- Humidity Cassette
- NanoQuant Plate™
- QC tools for IQ/OQ services
- Spark-Stack™ patent-pending microplate stacker*

*Spark-Stack microplate stacker supports all read modes without imaging.



Reagent dispenser with heating and stirring enhances application flexibility: Spark injectors offer a heating and stirring option for reagent storage. This is especially beneficial for cell-based applications, minimizing cold shock caused by reagent addition and enabling automated dispensing of viable cells within the reader.

Lid Lifter discs

The Lid Lifter is a convenient solution that helps researchers to increase workflow automation to decrease hands-on time for long-term incubation and in-between measurements, and further reduce sample evaporation. Simply add the sample to a Tecan microplate, cover with a lid with a Lid Lifter disc attached, place in the Spark reader and incubate for as long as required. The Spark Lid Lifter will remove the lid from the plate for readings at specified time intervals.



Lid Lifter discs come in 50 pcs/box.



Easy-to-use software designed for long-term studies

Live viewer mode

The live viewer mode of SparkControl software turns the reader into a digital microscope, allowing manual inspection of cells and optimization of focus levels, exposure times and LED intensities.

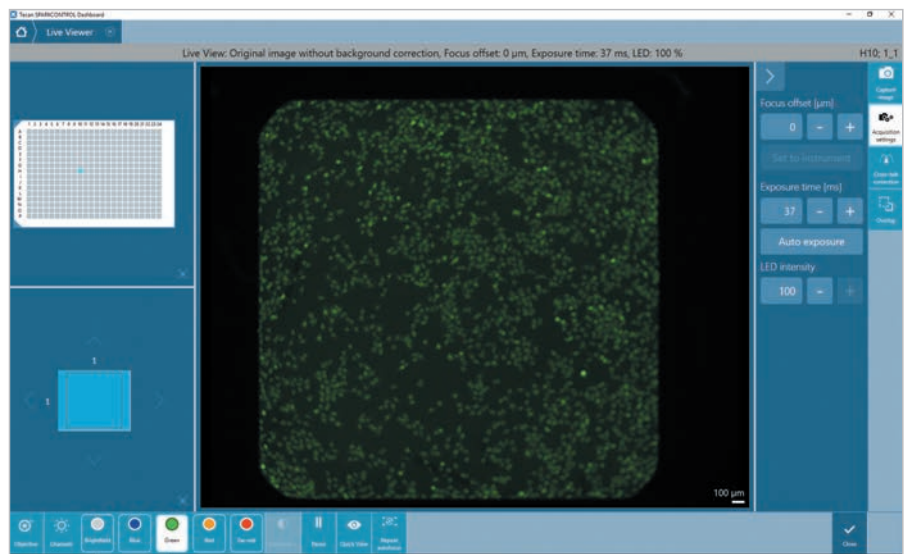

The live viewer mode turns the reader into a digital microscope.

ImageAnalyzer

Images acquired with the Spark Cyto can be automatically processed with ImageAnalyzer, Tecan's proprietary imaging software package. ImageAnalyzer offers you an array of customization options, making it easy to adjust and optimize imaging parameters such as cell size, segmentation and cell gating. Predefined analysis reports provide comprehensive and effortless documentation of your experiments.

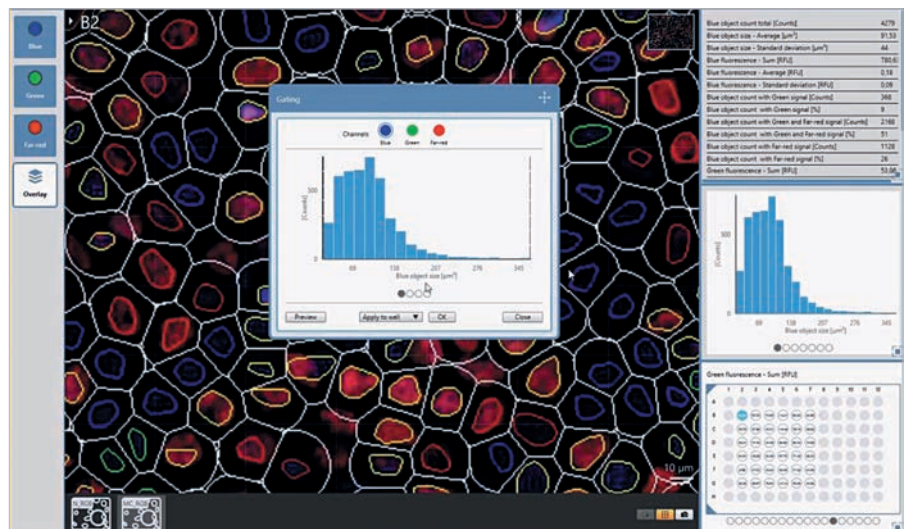

Spark Cyto's ImageAnalyzer offers easy data analysis for object segmentation, gating and object counting.



SparkControl enables automation of long-term kinetic assays, providing a hands-off solution for complex experimental set-ups. The imaging strip can be combined with any other programming strip, making it effortless and straightforward to create multiplex assays. The software uses an icon-driven, 'drag and drop' approach, making it suitable for users at any skill level.

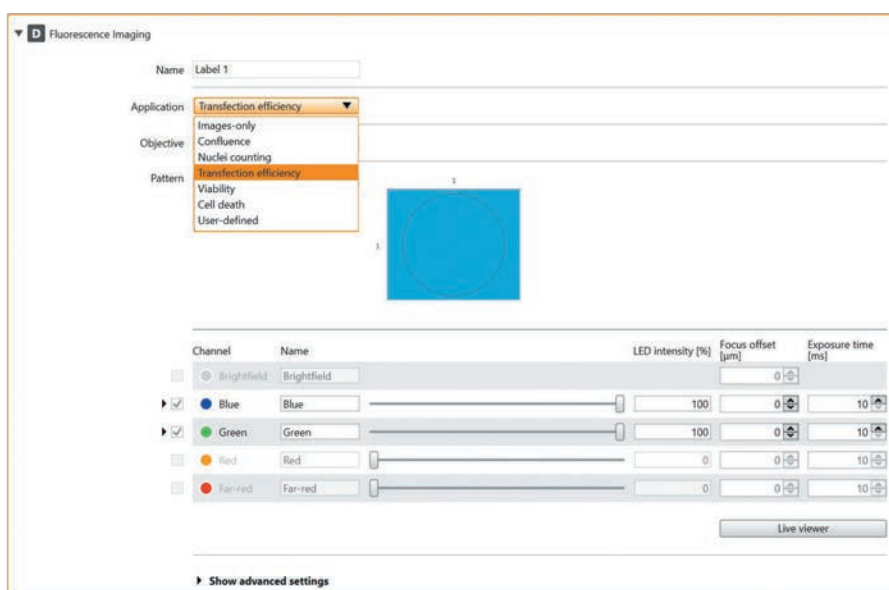

The fluorescence imaging strip in SparkControl's Method Editor.

Tecan Connect™ mobile app

Stay connected with your experiment wherever you are. Use the Tecan Connect mobile app to monitor instrument status and alert you when user interactions are required.



LEARN MORE:

<https://lifesciences.tecan.com/connect>

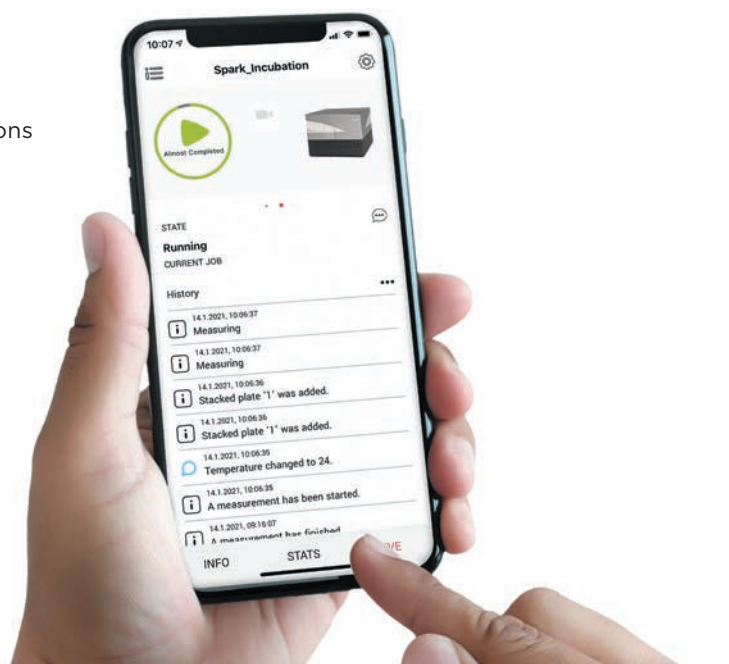

Automation.

And if you need a higher throughput?

Scale up your research with an automated live-cell analysis system. Tecan offers scalable automation solutions for end-point and kinetic live-cell experiments to meet your capacity needs – from a simple benchtop extension with a compact multi-plate cell incubator, to full workflow automation with Tecan's Fluent® liquid handling automation platform.

Enables higher throughput applications including cell imaging



Full workflow automation
from sample preparation to
detection

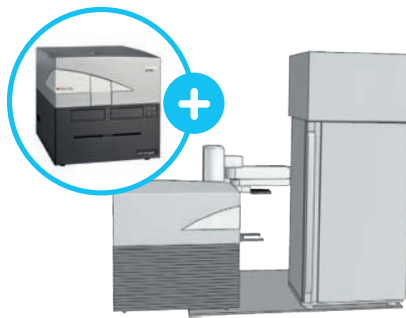

**High throughput
live-cell assays** with
up to 40 plates



**Third-party integration/
automation** to meet your
specific needs

BENCH TOP AUTOMATION WITH SPARK MOTION CONCEPT

Complete walk away automation for live-cell experiments

- Automated cell incubation and analysis of up to 40 plates increases throughput
- Multiplexed kinetic growth analysis (eg. luminescence and imaging) increases reproducibility
- Patented lid-lifting technology in Spark Cyto protects plates outside the incubator, saving costs for expensive safety cabinets
- Expandable with additional instruments, such as a dispenser or washer, for complete workflow automation

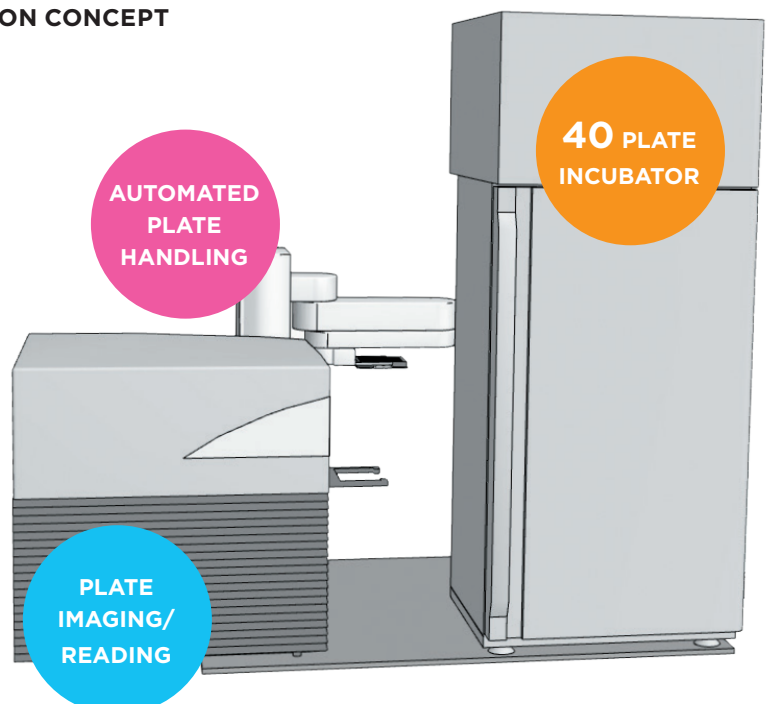

Capabilities*



Applications

- Label-free cell counting
- Nuclei counting
- Transfection efficiency
- Cell viability
- Apoptosis
- Confluence assessment
- Cell migration and wound healing
- ELISAs
- Low-volume DNA/RNA quantification
- Nucleic acid labeling efficiency
- Protein quantification
- Reporter gene assays
- HTRF®, DELFIA® and LanthaScreen®
- Transcreener®
- DLR®
- BRET – including NanoBRET®

Detection modes

- Fluorescence imaging (blue, green, red, far red)
- Bright field imaging
- Digital phase contrast imaging
- Absorbance – incl. UV/vis
- Fluorescence top and bottom
- Time-resolved fluorescence (TRF)
- Full spectral scanning capability for all measurement modes
- FRET
- TR-FRET
- Fluorescence polarization (FP)
- Luminescence – glow, flash, multicolor, scanning
- AlphaScreen®, AlphaLISA® and AlphaPlex®

Additional options

- Reagent dispensers with heating and stirring
- Humidity Cassette
- NanoQuant Plate
- QC tools for IQ/OQ services
- Spark-Stack microplate stacker
- Automation interface for higher throughput

*Capabilities depend on the Spark Cyto configurations.

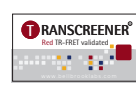

Bio-Formats compatibility

Images are saved in widely used jpg or tiff formats to make image analysis with alternative software products easy and seamless. In addition, Bio-Formats – an open source software plug-in that works with 150+ microscopy formats – is able to read Spark Cyto results, helping to simplify the use of a wide range of analysis tools.

Typical performance values⁺

Fluorescence imaging and cytometry

Imaging technologies	Fluorescence, bright field, digital phase contrast			
Imaging methods	Single color, multicolor, end-point, kinetics, whole well			
Sample formats	6- to 384-well ANSI/SLAS-format microplates			
Camera sensor	Grayscale, 5 Mpixel, CMOS Sony			
Objectives	2x (NA 0.08), 4x (NA 0.13), 10x (NA 0.30)			
Optical properties	Objective	Pixel resolution	Optical resolution	Field of view
	2x	3.45 μm	4.50 μm	8.47 x 7.09 mm
	4x	1.72 μm	2.77 μm	4.24 x 3.54 mm
	10x	0.69 μm	1.20 μm	1.69 x 1.42 mm
Channels	Bright field, four fluorescence channels (blue, green, red, far-red)			
Autofocus	Proprietary astigmatism-based technology			
Field of view	Whole well, 96- and 384-well imaging with a single image (2x and 4x objectives)			
Applications	Six pre-defined applications: confluence, nuclei counting, transfection efficiency, cell viability, multi-color analysis and cell death (apoptosis via Annexin V-FITC), plus user-defined applications			
Image collection rate	≤ 12 min for 96-well plate, whole well image with 2x, bright field and digital phase contrast			
	≤ 15 min for 96-well plate, center image with 10x, bright field, digital phase contrast + 1 fluorescence channel			
Analysis speed	≤ 20 min for 96-well plate, whole well image with 2x, bright field and digital phase contrast including real time confluence assessment			

Fluorescence - enhanced

Light source	High energy xenon flash lamp
Spectral range	Ex: 230–900 nm
	Em: 280–900 nm
Wavelength accuracy	Ex: <0.5 nm; Em: <0.5 nm
Wavelength reproducibility	<0.5 nm
Bandwidth	Adjustable from 5–50 nm
Optical mirrors	50 %, 510, 560, 625 nm built-in;
	410, 430, 458, 593, 660 nm user-selectable dichroics
Well scanning	Up to 100 x 100 data points
FI (fluorescence intensity)	Limit of detection ¹
Filter - top	≤ 8 amol/well (10 μl ; 1,536-well)
Fusion* - top	≤ 15 amol/well (10 μl ; 1,536-well)
Mono - top	≤ 20 amol/well (10 μl ; 1,536-well)
Filter - bottom	≤ 180 amol/well (10 μl ; 1,536-well)
Fusion - bottom	≤ 200 amol/well (10 μl ; 1,536-well)
Mono - bottom	≤ 220 amol/well (10 μl ; 1,536-well)

FP (fluorescence polarization)²

Spectral range	300–850 nm
Precision - Filter	≤ 1.25 mP
Precision - Fusion	≤ 2.0 mP
Precision - Mono	≤ 2.5 mP

TRF (time-resolved fluorescence)³

Limit of detection - Filter	≤ 0.5 amol/well (20 μl ; 384-well SV)
Limit of detection - Fusion	≤ 0.6 amol/well (20 μl ; 384-well SV)
Limit of detection - Mono	≤ 0.7 amol/well (20 μl ; 384-well SV)

Fastest read time

384-well plate (FI)	≤ 22 sec
1,536-well plate (FI)	≤ 34 sec

Fluorescence - standard

Light source	Dedicated xenon flash lamp
Spectral range	Ex: 230–900 nm
	Em: 280–900 nm
Wavelength accuracy	Ex: <1 nm; Em: <2 nm
Wavelength reproducibility	<1 nm
Bandwidth	Fixed @ 20 nm
Optical mirrors	50 %; 510 nm dichroic
Well scanning	Up to 100 x 100 data points
FI (fluorescence intensity)	Limit of detection ¹
Filter - top	≤ 25 amol/well (100 μl ; 384 well)
Fusion - top	≤ 35 amol/well (100 μl ; 384 well)
Mono - top	≤ 50 amol/well (100 μl ; 384 well)
Filter - bottom	≤ 500 amol/well (200 μl ; 96 well)
Fusion - bottom	≤ 700 amol/well (200 μl ; 96 well)
Mono - bottom	≤ 800 amol/well (200 μl ; 96 well)

FP (fluorescence polarization)²

Spectral range	300–850 nm
Precision - Filter	≤ 1.5 mP
Precision - Fusion	≤ 2.5 mP
Precision - Mono	≤ 3.0 mP

TRF (time-resolved fluorescence)³

Limit of detection - Filter	≤ 4.0 amol/well (100 μl ; 384-well)
Limit of detection - Fusion	≤ 6.5 amol/well (100 μl ; 384-well)
Limit of detection - Mono	≤ 10 amol/well (100 μl ; 384-well)

Fastest read time

96-well plate (FI)	≤ 13 sec
384-well plate (FI)	≤ 30 sec

Absorbance (enhanced or standard)

Light source	Dedicated xenon flash lamp
Spectral range	200–1,000 nm
	OD range 0–4 OD
Scan speed (200–1,000 nm)	≤5 sec
Wavelength accuracy	<0.3 nm
Wavelength reproducibility	≤0.3 nm
Wavelength ratio accuracy (260/230)	<0.08
Wavelength ratio accuracy (260/280)	<0.07
Precision @ 260 nm	<0.2 %
Accuracy @ 260 nm	<0.5 %
Limit of detection (nucleic acids)	<1 ng/μl

Plate formats for all read modes – enhanced

1-1,536 wells; NanoQuant Plate; cuvettes; RoboFlask®

Plate formats for all read modes – standard

1-384 wells; NanoQuant Plate; cuvettes; RoboFlask

Luminescence (enhanced or standard)

Spectral range	370–700 nm
Limit of detection – Glow ⁴	≤225 amol/well (25 μl; 384-well SV)
Limit of detection – Flash ⁵	≤12 amol/well (55 μl; 384-well)
Dynamic range	>9 orders of magnitude
Multi-color luminescence	38 spectral filters; OD1, OD2, OD3 attenuation filters

AlphaScreen (enhanced or standard)

Limit of detection	<100 amol/well bio-LCK-P ⁶ ; 20 μl
	<2.5 ng/ml Omnibeads ⁷ ; 20 μl
Uniformity	≤3.0 %
Z' value	>0.9
Fastest read times ⁸	≤2 min (384-well plate) ≤1 min (96-well plate)

Gas Control Module (GCM™)

Adjustable concentration range – CO ₂	0.04–10 % (vol.)
Adjustable concentration range – O ₂	0.1–21 % (vol.)
Concentration accuracy – CO ₂	<1 % (vol.)
Concentration accuracy – O ₂	<0.5 % (vol.)

Reagent injectors

Syringe sizes	0.5 ml; 1 ml; 2.5 ml
Pump speed	100–300 μl/sec
Injection volume	5–2,500 μl; step size: 1 μl
Dead volume	≤100 μl
Injection accuracy and precision	≤0.5 % at 450 μl

Temperature control

	Ambient +3 °C up to 42 °C
Uniformity	<0.5 °C

Shaking

Linear, orbital, double-orbital;
variable amplitudes and frequencies

*Specifications are subject to change. Performance values represent the average observed factory tested values.

*Fusion Optics: a combination of filter and monochromator on the excitation and emission sides

- 1) Detection limit for fluorescein
- 2) FP detection limit @ 1 nM fluorescein
- 3) Detection limit for europium
- 4) Detection limit for ATP (144-041 ATP detection kit SL, BioThema)
- 5) Detection limit for ATP (ENLITEN® Kit)
- 6) (PE# 6760620; P-Tyr-100 assay kit)
- 7) (PE# 6760626D; Omnibeads)
- 8) Including temp. correction

Spark Cyto multimode reader is For Research Use Only.

For product specifications refer to operators manual.

Live-cell imaging in real time: www.tecan.com/SparkCyto

.....
Australia +61 3 9647 4100 **Austria** +43 62 46 89 330 **Belgium** +32 15 42 13 19 **China** +86 21 220 63 206 **France** +33 4 72 76 04 80 **Germany** +49 79 51 94 170
Italy +39 02 92 44 790 **Japan** +81 44 556 73 11 **Netherlands** +31 18 34 48 17 4 **Nordic** +46 8 750 39 40 **Singapore** +65 644 41 886 **Spain** +34 93 595 25 31
Switzerland +41 44 922 89 22 **UK** +44 118 9300 300 **USA** +1 919 361 5200 **Other countries** +41 44 922 81 11
.....

Tecan Group Ltd. makes every effort to include accurate and up-to-date information within this publication, however, it is possible that omissions or errors might have occurred. Tecan Group Ltd. cannot, therefore, make any representations or warranties, expressed or implied, as to the accuracy or completeness of the information provided in this publication. Changes in this publication can be made at any time without notice. All mentioned trademarks are protected by law. In general, the trademarks and designs referenced herein are trademarks, or registered trademarks, of Tecan Group Ltd., Männedorf, Switzerland. A complete list may be found at <http://www.tecan.com/trademarks>. Product names and company names that are not contained in the list but are noted herein may be the trademarks of their respective owners. For technical details and detailed procedures of the specifications provided in this document please contact your Tecan representative.

Tecan is in major countries a registered trademark of Tecan Group Ltd., Männedorf, Switzerland.
© 2022 Tecan Trading AG, Switzerland, all rights reserved.

www.tecan.com

