



2022-2023 Product Catalog



Centrifuges



Shakers/Mixers



Homogenizers



Sterilizers



Temperature Control Equipment



Accuris Instruments



Benchmark Scientific, Inc. is pleased to present our 2022-2023 research products catalog. Since our inception, we have been providing research laboratories with innovative, cost effective products and solutions designed to improve laboratory efficiency, safety and results.

Our emphasis on next generation technology, quality and value has served our customers and our company well. As a result of recent growth, we have expanded our facilities, our staff and our product lines to serve you better. We welcome your questions, suggestions and comments.

Centrifuges Pg. 3

| | |
|------------------------------------|------------------------------|
| 8 and 12 Position Mini Centrifuges | Refrigerated Microcentrifuge |
| Specialty Mini Centrifuges | Compact Lab Centrifuges |
| Mini Plate Centrifuge | Hermle Centrifuges |
| High Speed Microcentrifuges | Sprint™ Clinical Centrifuge |

Shakers, Mixers & Rockers . . . Pg. 16

| | |
|---------------------------|----------------------|
| Vortex Mixers | Orbital Shakers |
| Two Dimensional Rockers | Rollers and Rotators |
| Three Dimensional Rockers | Stirrers |

Homogenizers Pg. 37

| | |
|---------------------------|--------------------------|
| HandHeld Homogenizer | Ultrasonic Homogenizer |
| Bead Beating Homogenizers | Refrigerated Homogenizer |

Autoclaves & Sterilizers Pg. 43

| | |
|-------------------------------|------------------------|
| MicroSterilizers / Cinerators | Glass Bead Sterilizers |
| Bench Top Autoclaves | |

Temperature Control Equipment Pg. 48

| | |
|---|--------------------|
| Hotplates and Stirrers | Water Baths |
| Incubators & CO ₂ Incubators | Shaking Incubators |
| Dry Baths (Heat Blocks) | Thermal Cyclers |

Also Available from Benchmark Pg. 68

| | |
|-------------------------------------|--|
| Microtube & PCR Plate Coolers | Media Storage Bottles (hybex™ glassware) |
| Agarose LE Powder & Agarose Tablets | |

Accuris Instruments Pg. 71

| | |
|------------------------|---------------------------------------|
| Laboratory Weighing | Gel Electrophoresis and Visualization |
| Liquid Handling | Cell Counting |
| Microplate Instruments | PCR & Electrophoresis Reagents |
| Electrophoresis | Automated Purification Systems |

Centrifugation



Pg. 4



myFuge™ Mini **Microcentrifuge**

Pg. 5



myFuge™ 12 **Microcentrifuge**

Pg. 6



StripSpin 12 & myFuge™ 5 **Microcentrifuges**

Pg. 7



PlateFuge™ **Microcentrifuge**

Pg. 8



MC12™ **High Speed Microcentrifuge**

Pg. 9



MC24 Touch™ **High Speed Microcentrifuge**

Pg. 10



LC-8™ Series **Centrifuges**

Pg. 11



Hermle **Refrigerated Microcentrifuge**

Pg. 12



Hermle **Large Capacity Centrifuges**

Pg. 14



Sprint™ Series **Centrifuges**

myFUGE™ Mini



CE

The myFuge™ Mini Microcentrifuge is a personal centrifuge that virtually fits in the palm of your hand. Ideal for quick spin downs of microtubes and PCR tubes, the myFuge is extremely easy to use. Simply close the lid and the rotor instantly reaches 6,000 rpm. Open the lid, and the improved braking system quickly and smoothly decelerates the rotor to a complete stop in just one second.

An eight-position microtube rotor is included and comes installed. Also included is a second rotor with increased capacity for four 0.2ml PCR strips (or 32 x 0.2ml tubes) which is stored in a convenient compartment on the bottom of the centrifuge. This compartment is also used for securing the included tube adapters for 0.5ml tubes.

A new **Clik-n-Lok™** rotor attachment system eliminates the requirement for set screws and tools during rotor exchange. Simply remove and attach rotors by hand, pulling or pressing the rotor onto the motor shaft.

Technical Data:

| | |
|----------------------------|--|
| Speed: | 6,000 rpm / 2,000 xg |
| Capacity: | 8 x 1.5/2.0ml tubes 32 x 0.2ml PCR tubes 4 x PCR strips (8 x 0.2ml) |
| Dimensions: (W x D x H) | 5.7 x 6.9 x 4.5 in. 14.5 x 17.8 x 11.4 cm |
| Weight: | 2.2 lbs. / 1 kg |
| Electrical: | Universal Voltage 100-240V, 50-60 Hz, 20W |
| Warranty: | 2 Year |

- + Clik-n-Lok™ instant rotor attachment
- + Eight position microtube rotor
- + Storage compartment for PCR rotor and 0.5ml adapters
- + Decelerates in just 1 second
- + Includes rotor for 4 PCR strips



Storage compartment



Includes both rotors



Available in 5 colors

Ordering Information:

| Item No. | Description: |
|------------|---|
| C1008-C* | MyFuge Mini Microcentrifuge, clear lid |
| C1008-B* | MyFuge Mini Microcentrifuge, blue lid |
| C1008-G* | MyFuge Mini Microcentrifuge, green lid |
| C1008-P* | MyFuge Mini Microcentrifuge, purple lid |
| C1008-R* | MyFuge Mini Microcentrifuge, red lid |
| C1008-A5-8 | Replacement adapter pack, 0.5ml 8/pk. |
| C1008-A2-8 | Replacement adapter pack, 0.2ml 8/pk. |

*Includes US plug. For EU plug, please add (-E).
All models include microtube rotor, PCR rotor and 0.5ml adapters.



myFUGE™ 12

- + COMBI-Rotor™ for tubes and strips
- + Twice the capacity of most mini centrifuges
- + Near silent operation
- + Starts & stops with closing/opening of the lid



Unique COMBI-Rotor



Compact, low profile design

Unlike traditional mini centrifuges, the new myFuge™ 12 eliminates the need to change rotors when switching between microtubes and PCR strips. The included, unique COMBI-Rotor™ is all that is required for running 12 microtubes and/or 4 (eight position) PCR strips.

With a fixed speed that produces 2,000 xg, this centrifuge is perfect for quick spin downs. Simply close the lid and the unit accelerates to 5,500 rpm. Open the lid, and the rotor quickly decelerates for removal of samples.

At just 5.5 inches wide and less than 4.5 inches tall, the myFuge 12 truly is a personal centrifuge with unmatched capacity and flexibility.

Technical Data:

| | |
|----------------------------|---|
| Speed: | 5,500 rpm / 2,000 xg |
| Capacity: | 12 x 1.5/2.0ml tubes 32 x 0.2ml PCR tubes 4 x PCR strips (8 x 0.2ml) |
| Dimensions: (W x D x H) | 5.5 x 7.9 x 4.4 in. 14 x 20 x 11.2 cm |
| Weight: | 2.2 lbs. / 1 kg |
| Electrical: | Universal Voltage 100-240V, 50-60 Hz, 50W |
| Warranty: | 2 Year |

Ordering Information:

| Item No. | Description: |
|------------|--|
| C1012* | myFuge 12 Microcentrifuge with Combi-Rotor |
| C1008-A5-6 | Adapter pack, 0.5ml 6/pk. |
| C1008-A2-6 | Adapter pack, 0.2ml 6/pk. |

*Includes US plug. For EU plug, please add (-E).

StripSpin™ 12 Microcentrifuge



CE

For technical data, please see model C1012

For labs using 12 position PCR strips

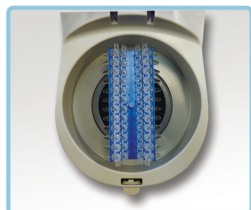

Holds up to 4 x PCR strips or 48 x 0.2ml tubes

Ordering Information:

| Item No. | Description: |
|------------|---|
| C1248* | StripSpin 12 Mini Microcentrifuge with 4 x 12 strip rotor |
| C1008-ROT | Optional rotor, 8 x 1.5/2.0ml |
| C1008-A5-8 | Optional adapter pack for C1008-ROT, 0.5ml, 8/pk. |

*Includes US plug. For EU plug, please add (-E).

myFuge™ 5 Microcentrifuge



CE

myFUGE™ 5

- + For quick spin downs of 5ml centrifuge tubes
- + Includes adapters for 5ml blood tubes
- + Starts and stops with closing/opening of the lid
- + Optional adapters for centrifuging cryovials

The myFuge™ 5 microcentrifuge includes a four position rotor for compatibility with a variety of 5ml test tubes, including 5ml snap cap centrifuge tubes. In addition, this combination rotor has four additional slots for centrifuging standard microtubes (1.5/2.0ml). Simply close the lid and the centrifuge quickly accelerates to the fixed speed of 5,500 rpm. Open the lid, and the rotor decelerates to a stop for removing samples.

The 5ml rotor positions accept 5ml centrifuge tubes directly, while 5ml blood and culture tubes (12x75mm) are accepted with the included adapters. The microtube positions are designed to accept 0.5 and 0.2ml tubes with the use of optional adapters.

Technical Data:

| | |
|-------------------------|--|
| Speed: | 5,500 rpm / 2,000 xg |
| Capacity: | 4 x 5ml tubes & 4 x 1.5/2.0ml |
| Dimensions: (W x D x H) | 5.5 x 7.9 x 5.5 in. 14 x 20 x 14cm |
| Weight: | 2.2 lbs. / 1 kg |
| Electrical: | Universal Voltage 100-240V, 50-60 Hz, 50W |
| Warranty: | 2 Year |

Ordering Information:

| Item No. | Description: |
|------------|--|
| C1005* | myFuge 5 Mini Centrifuge with combination rotor , 4 x 5ml & 4 x 1.5/2.0ml |
| C1005-AC2 | Adapter pack, for cryovials (0.5 to 2.0ml) and 1.5/2.0ml HPLC vials, 4/pk. |
| C1008-A5-6 | Adapter pack, 0.5ml, 6/pk. |
| C1008-A2-6 | Adapter pack, 0.2ml, 6/pk. |

*Includes US plug. For EU plug, please add (-E).

600
RCF

PlateFuge™ Microplate Centrifuge



PLATEFUGE™

MICROPLATE MICROCENTRIFUGE

- + Quickly spins down droplets in PCR plates
- + Unique, patented rotor design prevents sample spillage
- + Accepts all popular PCR plates (skirted, semi and non) and most microtiter plates
- + Less than half the size of traditional centrifuges

CE

Benchmark's PlateFuge™ is the first "mini" sized centrifuge with a swing out rotor for microplates. Centrifugation of plates before PCR ensures all reactants are in the bottom of the wells for optimized concentrations and improved yields.

In spite of its remarkably small footprint (9 x 10 in.), the PlateFuge™ includes a uniquely designed, patented swing out rotor capable of securing two microplates. The easily accessible rotor chamber includes two plate carriers that rest at a 75° angle. This allows plates to be inserted confidently without sealing tapes or caps. Upon closing the lid of the centrifuge, the rotor accelerates and the centrifugal force "swings" the plates into a vertical position. Any droplets on the walls of the plate, quickly concentrate into the well bottoms.

With a g-force of 600 xg, most samples can be spun down in less than 20 seconds. To end a run, simply open the lid and the automatic, electronic brake brings the rotor to a quick, smooth stop in about 4 seconds. Plates can then be easily removed from the rotor.



Before & after centrifugation
(angled position)



During centrifugation
(horizontal position)

Technical Data:

| | |
|----------------------------|---|
| Speed: | 2550 rpm / 600 xg |
| Capacity: | 2 x 2 PCR plates* 2 x microtiter plates (up to 25mm) 24 x 0.2ml PCR strips |
| Deceleration: | 4 seconds |
| Dimensions: (W x D x H) | 9.2 x 10.2 x 7.75 in. 23 x 26 x 19.7 cm |
| Weight: | 9 lbs. / 4.1 kg |
| Electrical: | 115 or 230V, 50-60 Hz, 250W |
| Warranty: | 2 Years |

*When stacking skirted PCR plates, max. capacity is 4 plates.

Ordering Information:

| Item No. | Description: |
|------------|--|
| C2000* | PlateFuge Microplate Centrifuge with rotor and plate carriers |
| C2000-A02 | Tube adapter, holds 96 x 0.2ml or 8 and 12 position PCR strips, 2/pk. |
| C2000-DWMP | Optional rotor with carriers for deep well plates up to 35mm tall (speed: 1500rpm) |

*115V with US plug. For 230V (EU plug), please add (-E).

MC-12™ High Speed Microcentrifuge

16,100
RCF

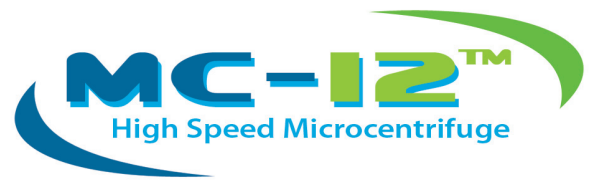

- + Less than 9 inches wide
- + Large LCD with rcf conversion
- + Whisper quiet operation
- + Decelerates in just 10 seconds
- + 12 tube capacity (1.5/2.0ml)

CE



Benchmark's MC-12 is the first and only compact microcentrifuge capable of achieving centrifugal speeds up to the critical threshold of 16,000 xg, often held as the standard for many molecular biology/DNA protocols. A brushless, maintenance free drive system makes it powerful, yet compact enough to allow each work station to be fully equipped with a personal centrifuge.



High speed range



Large LCD controls

The MC-12 defines a new class of microcentrifuge: compact, quick, powerful and affordable. All aspects of microcentrifuge performance were taken into consideration and no compromises were made. In addition to its unsurpassed speed, the MC-12 also delivers shortened acceleration/deceleration times, whisper quiet operation and a computer-designed airflow pattern to minimize sample temperature increases during longer runs at high speeds.

All operating parameters are set using a single, conveniently located control knob. The large, bright LCD provides a clear indication of time and rpm or g-force. A separate momentary spin button permits instant spin downs, without setting or disturbing any preset parameters. The aircraft grade aluminum rotor accepts 1.5 to 2.0ml tubes directly, as well as 0.5 and 0.2ml tubes with optional adapters. For applications requiring sub-ambient temperatures, the MC-12 is cold room safe.

Technical Data:

| | |
|-------------------------|--|
| Speed Range: | 500 to 15,500 rpm (up to 16,100xg) |
| Capacity: | 12 x 1.5/2.0ml |
| Deceleration: | 10 seconds |
| Acceleration: | 12 seconds |
| Speed Increment: | 100 rpm or 100 rcf |
| Timer: | 20 sec. to 99 min. / cont. |
| Momentary: | Yes |
| Dimensions: (W x D x H) | 8.7 x 10.6 x 5.9 in. 22 x 27 x 15cm |
| Weight: | 10.5 lbs / 4.8 kg |
| Electrical: | 115 or 230V, 50-60 Hz, 100W |
| Warranty: | 2 years |

Ordering Information:

| Item No. | Description: |
|------------|---|
| C1612* | MC-12 High Speed Microcentrifuge with 12 position rotor |
| C1008-A5-6 | Optional adapter pack, 0.5ml 6/pk. |
| C1008-A2-6 | Optional adapter pack, 0.2ml 6/pk. |

*115V with US plug. For 230V (EU plug), please add (-E).

16,800
RCF

MC-24 Touch™ High Speed Microcentrifuge



CE



Touch Control



Quiet Operation



High Speed

MC-24™ Touch High Speed Microcentrifuge

- + Full color touch screen
- + mySpin™ 1 button program recall
- + COMBI-Rotor™ accepts tubes and strips
- + Compact design, 9 x 12 x 7.75 in.
- + Unique air-flow system, keeps samples cool



Unique COMBI-Rotor™
Accepts tubes and strips
(includes lid)



Full-color Touch Screen

Benchmark's MC-24 Touch is the first microcentrifuge in its class with the convenience of touch pad control. In addition, this model comes complete with a unique COMBI-Rotor™ that accepts both standard microtubes and PCR strips, making this the ideal microcentrifuge for any microbiology laboratory.

The large, color touch screen shows actual speed (in rpm or rcf) along with set and remaining time. Up to 9 speed/time profiles can be stored in memory and the home screen displays a "mySpin" icon for instant recall of a designated favorite profile.

Supplied with Benchmark's unique COMBI-Rotor™, the MC-24 Touch will accept 24x1.5/2.0ml tubes and 2 strips of 0.2ml tubes (16x0.2ml) without requiring separate adapters. Samples are kept cool, even during extended runs at the maximum speed setting by a proprietary air flow system that moves air evenly and quietly throughout the chamber.

The MC-24 Touch is cold room safe and carries a 2 year warranty.

Technical Data:

| | |
|----------------------------|---|
| Speed Range: | 200 to 13,500 rpm (up to 16,800xg) |
| Capacity: | 24 x 1.5/2.0ml 2 x PCR Strips (16 x 0.2ml) |
| Speed Increment: | 100 rpm or 100 rcf |
| Timer: | 20 sec. to 99 min. / cont. |
| Momentary: | Yes |
| Dimensions: (W x D x H) | 9 x 12 x 7.75 in. 23 x 30.5 x 19.7cm |
| Weight: | 14 lbs / 6.4 kg |
| Electrical: | 115 or 230V, 50-60 Hz, 250W |
| Warranty: | 2 years |

Ordering Information:

| Item No. | Description: |
|-------------|---|
| C2417* | MC-24 Touch Microcentrifuge with 24 place COMBI-Rotor |
| C1008-A5-6 | Optional adapters for 0.5ml tubes in standard rotor, 6/pk |
| C2417-ROT5 | Optional rotor, 8x 5ml (13,500rpm) |
| C2417-5-ADP | Optional adapters for 2ml cryovials in 8x5ml rotor, 8/pk |

*115V with US plug. For 230V (EU plug), please add (-E).



CE

- + Digital speed control with rcf conversion
- + Safety lid-lock prevents opening the lid until the rotor stops
- + Unique air flow design limits increase in sample temperature
- + Eight position rotor accepts tubes ranging from 5ml to 15ml
- + Ideal for PPP and PRP blood separations



15ml Conical Centrifuge Tubes



15ml Blood Collection Tubes



10ml Blood Collection Tubes



5-7ml Blood Collection Tubes (requires adapter)

Benchmark's LC-8 Series of laboratory centrifuges is uniquely designed to meet a wide range of applications in both the clinical and research laboratory. An eight position rotor is included and designed to directly accept 10ml and 15ml test-tubes (conical or round bottom), while optional adapters are also available for use with all popular sizes of blood collection and culture tubes. Unlike most compact centrifuges in this class, the rotor can be easily removed from the chamber for cleaning.

The back-lit, liquid crystal display provides full control over the set run time and rotational speed. The rotational speed can be set/viewed in rpm or rcf and acceleration/deceleration levels can be easily adjusted in the advanced settings mode.

To ensure safety, the digital microprocessor ensures that the lid has been closed and that the safety lid lock is engaged prior to starting a centrifugation cycle. In addition, an advanced imbalance detection system constantly monitors the balance and vibration, automatically bringing the rotor to a stop if an imbalance is detected.

Technical Data:

| | LC-8 | LC-8 Plus |
|-------------------------|--|-------------------------|
| Speed Range: | 400 - 3,500rpm (1500xg) | 400 - 5,000rpm (3070xg) |
| Capacity: | 8 x 15ml | 8 x 15ml |
| Accel/Decel: | 9 sec. / 25 sec. | 19 sec. / 39 sec. |
| Increment: | 100 rpm increments | |
| Timer: | 20 sec. to 99 min. | |
| Momentary: | Yes | |
| Dimensions: (W x D x H) | 11.6 x 14.4 x 8.3 in. 29.5 x 36.5 x 21 cm | |
| Weight: | 15 lbs / 6.8 kg | |
| Electrical: | 115 or 230V, 50-60 Hz, 150W | |
| Warranty: | 2 years | |

Ordering Information:

| Item No. | Description: |
|-------------|--|
| C3100* | LC-8 Centrifuge with 8 x 15ml rotor (maximum speed: 3,500rpm / 1,500xg) |
| C3200* | LC-8 Plus Centrifuge with 8 x 15ml rotor (maximum speed: 5,000rpm / 3,070xg) |
| C3100-ADP | Optional adapters for 5ml & 7ml blood collection/culture tubes, 8/pk |
| C3100-130RS | Optional adapters for 130mm tall blood collection/culture tubes, 8/pk |
| C2570 | Optional adapters for 5ml centrifuge tubes, 4/pk |

*115V with US plug. For 230V (EU plug), please add (-E).

21,631
RCF

HERMLE™ Z216-M Series High Speed Microcentrifuges

HERMLE Benchmark

- + Unique 44 place micro rotor
- + High speed, up to 21,379 x g
- + Available with refrigeration
- + Multiple rotor options for microtubes, PCR strips and 5ml tubes



CE



44 X 1.5/2.0ml
Z216-4420



12 X 5ml conical
Z216-1205



COMBI-Rotor™
24 x 1.5/2ml and 4 x PCR
Z216-2420S

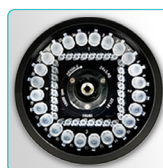

Holds both 1.5/2.0ml and PCR tubes!

Compact, quiet, and powerful are just a few of the features found on the Z216 Series Microcentrifuges. Add to this, the versatility of eight available rotor options, and the result is the ideal microcentrifuge for the modern molecular biology laboratory.

All common microtubes (0.2ml, 0.5ml, 1.5ml, 2.0ml) can be accepted as well as PCR strips, hematocrit tubes, and even 5.0ml centrifuge tubes. Advanced microprocessor controls allow for setting/displaying of the rotational speed in either rpm or rcf. In addition to retrieving saved programs, the easy to use front panel can adjust accel/decel rates, and change the end of run alarm tone.

Despite a remarkably small footprint, the Z216 series offers high output with a uniquely designed 44 x 1.5ml dual row rotor, nearly doubling the capacity when compared to traditional microcentrifuges. A unique COMBI-Rotor™ for 24 x 1.5/2.0ml and 4 x PCR strips is also available, featuring our new Quick-Seal™ biocontainment lid that opens and locks with only a quarter turn.

In the Z216-MK model, a powerful, compressor driven cooling system maintains temperatures as low as -20°C and is designed to reach 4°C (from room temperature) in less than 10 minutes.

Technical Data:

| | |
|----------------------------|--|
| Speed Range: | 200 to 15,000 rpm (up to 21,631xg) |
| Max. Capacity: | 44 x 1.5/2.0ml 4 x PCR Strips (32 x 0.2ml) |
| Speed Increment: | 10 rpm or 10 rcf |
| Timer: | 10 sec. to 99h 99 min. / cont. |
| Temp. Range | -20°C to 40°C (Z216-MK) |
| Momentary: | Yes |
| Dimensions: (W x D x H) | 11 x 15.3 x 11.4 in. 11 x 21.6 x 11.4 in. (Z216-MK) |
| Weight: | 37.4 lbs / 17 kg 77 lbs / 35 kg (Z216-MK) |
| Electrical: | 115 or 230V, 50-60 Hz, 280W (Z216-MK: 560W) |
| Warranty: | 5 years |

Ordering Information:

| Item No. | Description: |
|-----------------------|---|
| Z216-M* | Z216-M High Speed Microcentrifuge |
| Z216-MK* | Z216-MK Refrigerated High Speed Microcentrifuge |
| Z216-2420 | Rotor, 24 x 1.5/2.0ml |
| Z216-2420S | NEW! COMBI-rotor with Quick-Seal biocontainment lid for 24 x 1.5/2.0ml and 4 x PCR Strips |
| Z216-4420 | Rotor, 44 x 1.5/2.0ml |
| Z216-3020H | Rotor, 30 x 1.5/2.0ml with hermetically sealed lid |
| Z216-3202 | Rotor, 4 x PCR Strips (32 x 0.2ml tubes) |
| Z216-6405 | Rotor, 64 x 0.5ml |
| Z216-1205 | Rotor, 12 x 5ml centrifuge tubes |
| Z216-24HEM | Rotor, hematocrit, 24 x capillary |
| More rotors available | Visit www.hermleusa.com for a complete listing |

*115V with US plug. For 230V (EU plug), please add (-E).

HERMLE™ Z446 Series High Capacity Universal Centrifuges

24,325
RCF

HERMLE Benchmark



- + High capacity, 4 x 750ml accepts 28 x 50ml or 68 x 15ml
- + Advanced programming with auto rotor recognition
- + Available with refrigeration
- + Ideal for tissue culture laboratories

CE



Z446-750
Swing out rotor with round buckets

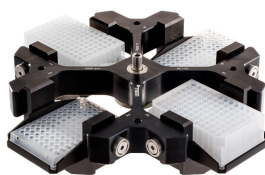

Z446-750-MP
Microplate carriers for swing out rotor



Z446-MP-BUK
Sealable microplate bucket for swing out rotor

| Inserts: (for round buckets) | Tube/Bottle | qty./insert | qty./rotor |
|------------------------------|---------------|-------------|------------|
| Z446-750-A500 | 500ml conical | 1 | 4 |
| Z446-750-A250 | 250ml bottle | 1 | 4 |
| Z446-750-A250F | 250ml bottle | 1 | 4 |
| Z446-750-A225 | 225ml conical | 1 | 4 |
| Z446-750-A50 | 50ml conical | 7 | 28 |
| Z446-750-A15 | 15ml conical | 17 | 68 |
| Z446-750-A10 | 10ml | 18 | 72 |
| Z446-750-A57 | 5/7ml | 21 | 84 |

The Z446 Universal Centrifuge Series offers the highest capacity of any benchtop Hermle-Benchmark model. With aircraft grade, premium alloy construction, the 4 x 750ml swing out rotor can withstand centrifugal forces upwards of 4,000 xg with full loads of up to 28 x 50ml or 68 x 15ml tubes.

Advanced microprocessor controls allow for instant rotor identification, which automatically converts the rotational speed to the relevant g-force (rcf), preventing the user from setting a speed above the capabilities of the installed rotor. In addition to retrieving saved programs, the easy to use front panel can adjust accel/decel rates, and change the end of run alarm tone.

Rotor exchange is simple and requires less than one minute. An included rotor wrench can be used to loosen and install all rotors. As soon as the rotor is placed on the motor shaft, the identification process activates and the installed rotor code is displayed on the backlit LCD display.

Technical Data:

| | |
|----------------------------|---|
| Speed Range: | 200 to 16,000 rpm (up to 24,325xg) |
| Capacity: | 4 x 750ml 28 x 50ml 68 x 15ml |
| Speed Increment: | 10 rpm or 10 rcf |
| Timer: | 10 sec. to 99h 99 min. / cont. |
| Temp. Range | -20°C to 40°C (Z446-K) |
| Momentary: | Yes |
| Dimensions: (W x D x H) | 21.3 x 26.4 x 15.4 in. 28.7 x 26.4 x 15.4 in. (Z446-K) |
| Weight: | 174 lbs / 79 kg 244 lbs / 111 kg (Z446-K) |
| Electrical: | 115 or 230V, 50-60 Hz, 640W (Z446-K: 1630W) |
| Warranty: | 5 years |

Ordering Information:

| Item No. | Description: |
|-----------------------|---|
| Z446* | Z446 Large Capacity Universal Centrifuge |
| Z446-K* | Z446-K Refrigerated Large Capacity Universal centrifuge |
| Z446-750 | 4 x 750ml swing out rotor with round buckets |
| Z446-750-MP | Microplate carriers for Z446-750-AC rotor, 2/pk |
| Z446-MP-BUK | Rectangular microplate buckets for Z446-750-AC rotor, 2/pk |
| Z446-04500 | Rotor, 4 x 500ml bottle |
| Z366-06250 | Rotor, 6 x 250ml bottle |
| Z326-0685 | Rotor, 6 x 85ml |
| Z326-1050 | Rotor, 10 x 50ml conical |
| Z326-2010 | Rotor, 20 x 10ml |
| More rotors available | Visit www.hermleusa.com for a complete listing |

*115V with US plug. For 230V (EU plug), please add (-E).

also available from Hermle...



Z206-A Compact Centrifuge

Max. Speed: 6,000 rpm
 Max. g-Force: 4,427 xg
 Max. Capacity: Swing out
 6 x 5ml
 4 x 7ml
 Fixed angle
 6 x 50ml
 12 x 15ml
 18 x 1.5/2.0ml



Z326-K Refrigerated Universal Centrifuge

Max. Speed: 18,000 rpm
 Max. g-Force: 23,542 xg
 Max. Capacity: Swing out
 4 x 145ml
 8 x 50ml
 12 x 15ml
 6 x microplates
 Fixed angle
 10 x 50ml
 30 x 15ml
 44 x 1.5/2.0ml
 Temp Range: -20° to 40°C



Z496-K Floor Standing High Capacity Centrifuge

Max. Speed: 10,500 rpm
 Max. g-Force: 16,022 xg
 Max. Capacity: Swing out
 4 x 1000ml
 40 x 50ml
 96 x 15ml
 24 x microplates
 Fixed angle
 4 x 500ml
 6 x 250ml
 10 x 50ml
 Temp Range: -20° to 40°C



Z287-A Microcentrifuge PLUS

Max. Speed: 14,000 rpm
 Max. g-Force: 16,058 xg
 Max. Capacity: Swing out
 4 x 50ml
 8 x 10ml
 2 x microplates
 Fixed angle
 6 x 50ml
 12 x 15ml
 24 x 1.5/2.0ml
 Temp Range: -20° to 40°C

HERMLE

Benchmark

For a complete listing of all centrifuges and accessories please visit www.hermleusa.com

Unique Accessories *For Z446-750-MP only

PCR Stacking Adapter

Stacks PCR plates for unmatched capacity! *
 Z446-MP-STK



Universal Chamber Slide and Dish Carrier

Fits ANY microplate carrier!
 Z326-MPCA



BucketBuddy™ Magnetic Bucket/Tube Caddy

Your centrifuge's new best friend! (select models only)
 Z326-BKR



| | | | |
|--|--|--|--|
| Z446-04500 4 x 500ml 8,000 rpm/ 10,374 xg | Z326-1050 10 x 50ml 10,500 rpm/ 16,022 xg | Z326-02MP 2 x 3 microplate 4,500 rpm/ 2,716 xg | Z326-1220-36 12 x 1.5/2.0ml 30,000 rpm/ 65,395 xg |
| Z366-06250 6 x 250ml 8,000 rpm/ 10,016 xg | Z326-3015 30 x 15ml 4,500 rpm/ 2,830 xg | Z326-100H 4 x 100ml Swing out rotor with buckets 4,500 rpm/ 2,716 xg | Z496-750-BLD 750ml Blood bag bucket 4,600 rpm/ 5,274 xg |

Sprint™ 6H and Sprint™ 6H PLUS Clinical Centrifuges

2,504
RCF



Sprint™ 6H by Benchmark

- + Includes 6 place swing out rotor
- + Accepts blood tubes up to 10ml
- + Ideal for Coag, PPP and urinalysis
- + Locking Lid and digital timer

The Sprint™ 6H and 6H PLUS are compact clinical centrifuges that include a six position, swing-out rotor. Prior to centrifugation, tubes are loaded vertically. Once the centrifuge starts, tubes swing to a horizontal position, providing the flat-line separation that is commonly preferred for further analysis.

The Sprint 6H centrifuge is designed for use with 10ml blood collection tubes (16x100mm), while smaller tubes (12 x 75/100mm) can be centrifuged with the use of optional adapters. The Sprint 6H PLUS model features a larger chamber/rotor and has the added capability of centrifuging tubes up to 15ml.

Technical Data (Sprint 6H):

| | |
|----------------------------|------------------------------|
| Speed Range: | 3,400 rpm / 1,600 xg |
| Capacity: | 6 x 10ml 6 x 5-7ml (13mm) |
| Speed Increment: | Fixed |
| Timer: | 30 mins. (1 min increments) |
| Dimensions: (W x D x H) | 12.8 x 11.5 x 9 in. |
| Weight: | 17.6 lbs / 8 kg |
| Electrical: | 115 or 230V, 50-60 Hz |
| Warranty: | 2 years |



Sprint™ 6H^{Plus}

- + Increased speed up to 4,000rpm / 2504xg
- + Includes 6 place swing out rotor
- + Adjustable speed control in rpm or rcf
- + Safety imbalance detection system
- + Optional 12 x 15ml fixed angle rotor (conical or round bottom)

Technical Data (Sprint 6H Plus):

| | |
|----------------------------|---|
| Speed Range: | 200 to 4,000 rpm / 2,504 xg |
| Capacity: | 6 x 15ml 6 x 5-7ml (13mm) 12 x 15ml (fixed angle) |
| Speed Increment: | 100 rpm |
| Timer: | 10 sec. to 99h 99 min. / cont. |
| Momentary: | Yes |
| Dimensions: (W x D x H) | 12 x 16 x 10.5 in. |
| Weight: | 21 lbs / 9.5 kg |
| Electrical: | 115 or 230V, 50-60 Hz |
| Warranty: | 2 Years |

Ordering Information:

| Item No. | Description: |
|--------------|--|
| C5000-6H* | Sprint™ 6H centrifuge with 6 x 10ml swing out rotor |
| C5000-6H-PT* | Sprint™ 6H portable kit, w/12V car adapter, leveling legs |
| C3303-6HP* | Sprint™ 6H PLUS centrifuge with 6 x 15ml swing out rotor |
| C3303-1215 | Optional 12 x 15ml fixed angle rotor (for C5000-6HP only) |
| C5000-ADP | Optional adapters for 5ml & 7ml blood collection/culture tubes, 8/pk (Sprint 6H and 8) |
| C3100-ADP | Optional adapters for 5ml & 7ml blood collection/culture tubes, 8/pk (Sprint 6H Plus) |

*115V with US plug. For 230V (EU plug), please add (-E).

4,445
RCF

Sprint™ 8 and Sprint™ 8 PLUS Clinical Centrifuges



Sprint™ 8

- + Includes 8 place fixed angle rotor
- + Accepts blood tubes up to 15ml
- + Ideal for Coag, PPP and urinalysis
- + Locking Lid and digital timer

The Sprint™ 8 and 8 PLUS are compact clinical centrifuges with eight position, fixed angle rotors for centrifuging tubes up to 15ml. The standard Sprint™ 8 provides a fixed speed of 3,400 rpm / 1,600xg. The PLUS model greatly reduces spin times, with adjustable speed up to 6,800 rpm / 4,445 xg.

With intuitive controls and displays, these centrifuges are ideal for a variety of applications, including coag, PPP, PRP, and urinalysis.

Technical Data (Sprint 8) :

| | |
|----------------------------|---|
| Speed Range: | 3,400 rpm / 1,600 xg |
| Capacity: | 8 x 15ml conical or round 8 x 5-7ml (13mm) |
| Speed Increment: | Fixed |
| Timer: | 30 mins. (1 min increments) |
| Dimensions: (W x D x H) | 12.8 x 11.5 x 9 in. |
| Weight: | 17.6 lbs / 8 kg |
| Electrical: | 115 or 230V, 50-60 Hz |
| Warranty: | 2 years |

Sprint™ 8 PLUS

- + Increased speed up to 6,800rpm / 4,445xg
- + High capacity rotor, 8 tubes up to 15ml
- + Unique EZ-Scroll™ touch pad
- + 99 program memory storage
- + Control of speed in in both rpm and rcf
- + Safety imbalance detection system



Technical Data (Sprint 8 Plus):

| | |
|----------------------------|---|
| Speed Range: | 200 to 6,800 rpm / 4,445 xg |
| Capacity: | 8 x 15ml (4 x 15ml conical) 8 x 5-7ml (13mm) |
| Speed Increment: | 10 rpm / 10 rcf |
| Timer: | 10 sec. to 99h 99 min. / cont. |
| Momentary: | Yes |
| Dimensions: (W x D x H) | 11 x 13.7 x 9.5 in. |
| Weight: | 17.6 lbs / 8 kg |
| Electrical: | 115 or 230V, 50-60 Hz |
| Warranty: | 5 Years |

Ordering Information:

| Item No. | Description: |
|-------------|---|
| C5000-8* | Sprint™ 6H centrifuge with 8 x 15ml rotor |
| C5000-8-PT* | Sprint™ 8 portable kit, w/12V car adapter, leveling legs |
| Z207-A* | Sprint™ 8 PLUS centrifuge with 8 x 15ml rotor |
| C5000-ADP | Optional adapters for 5ml & 7ml blood collection/culture tubes, 8/pkg (Sprint 6H and 8) |
| Z326-15-A5 | Optional adapters for 5ml, 2/pkg (Sprint 8 PLUS) |
| Z326-15-A7 | Optional adapters for 7ml, 2/pkg (Sprint 8 PLUS) |

*115V with US plug. For 230V (EU plug), please add (-E).

Shakers, Mixers and Rockers

Pg. 18



Vornado™ Mini Vortexer

Pg. 19



BenchMixer™ Vortex Mixers

Pg. 20



Mortexer™ Vortex Mixer

Pg. 21



BenchMixer™ XL Vortex Mixer

Pg. 22



TubeRocker and BenchBlotter™ Fixed Speed Rocker

Pg. 23



BenchRocker™ 2D Variable Rocker

Pg. 23



Everlast™ 247 Variable Rocker

Pg. 24



BlotBoy™ & BioMixer™ Fixed Speed 3D Rockers



NEW! www.BenchMotion.com



Visit BenchMotion.com for a video representation of all of Benchmark's available shaking motions.



Pg. 26

BenchWaver™ 3D (Undulating) Rocker



Pg. 27

Orbi-Blotter™ Low Speed Orbital Shaker



Pg. 28-29

Orbi-Shaker™ Orbital Shakers



Pg. 29

Orbi-Shaker™ MP Microplate Shaker



Pg. 30

Orbi-Shaker™ CO₂ Remote Shakers



Pg. 32

Roto-Mini™ Rotator Series

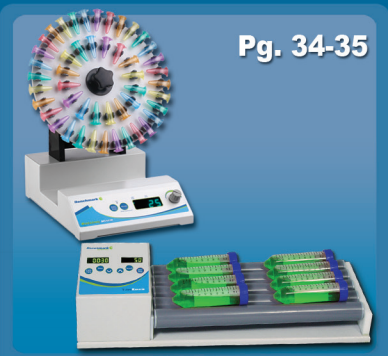

Pg. 34-35

Benchmark™ Rotating Mixer and Tube Roller



Pg. 36

Benchmark™ Overhead Stirrers



Vornado™ Miniature Vortex Mixer



VORNADO™ MINIATURE VORTEX MIXER

- + Powerful vortexing, for tubes up to 50ml
- + Insta-Touch™ pressure activated operation
- + “Mini” sized, less than 4” wide



Insta-Touch™ pressure activation



Extremely compact

Powerful is the best word to describe this *mini* vortexer. With a 4mm orbit and fixed speed of 2,800rpm, the Vornado instantly vortexes even the largest samples, including nearly full 50 ml tubes. Despite its powerful motor, the Vornado has a footprint of less than 4x4 inches, allowing it to fit on the most crowded bench.

Insta-Touch operation means that the motor is automatically activated with slight pressure on the center of the cup head. Operation is smooth, quiet and efficient. When pressure is removed, operation of the motor ceases.

The Vornado's unique head design prevents liquids from entering the housing, prolonging motor life. The unit is available with five different color cup heads.

Technical Data:

| | |
|----------------------------|--|
| Speed: | 2,800rpm (fixed) |
| Motor Activation: | Touch |
| Orbit: | 4mm |
| Dimensions: (W x D x H) | 3.7 x 3.9 x 2.6 in. 9.4 x 9.9 x 6.6 cm |
| Operating Temp. Range: | +4°C to +45°C |
| Weight: | 1 lb (0.4kg) |
| Electrical: | Universal Voltage 100 to 240V, 50-60Hz, 50W |
| Warranty: | 2 Years |

Ordering Information:

| Item No. | Description: |
|----------|---|
| BV101* | Vornado Miniature Vortex Mixer, gray cup head |
| BV101-B* | Vornado Miniature Vortex Mixer, blue cup head |
| BV101-G* | Vornado Miniature Vortex Mixer, green cup head |
| BV101-P* | Vornado Miniature Vortex Mixer, purple cup head |
| BV101-R* | Vornado Miniature Vortex Mixer, red cup head |



*Includes US plug. For EU plug, please add (-E).



BenchMixer™ V2

- + Reversible top: Use “Cup” or “Flat/Dimpled” Surface
- + Powerful motor for INSTANT vortexing
- + Q-Drive™ dynamic balancing system
- + Variable speed with touch or continuous operation

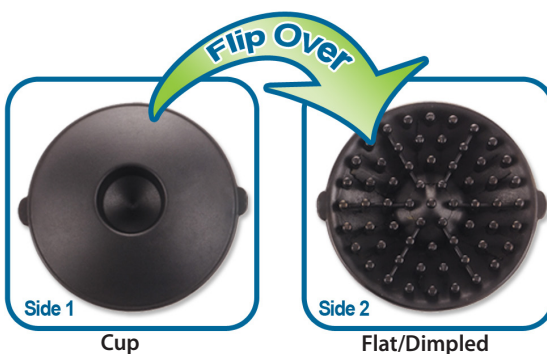

Reversible Top

The BenchMixer™ V2 utilizes a smooth and powerful mixing technology similar to the original BenchMixer, with the advantage of a uniquely designed reversible rubber head that can be attached to the mixer in two orientations. For the vortexing of single tubes, the cupped surface would generally be preferred. However, for applications requiring a flat/dimpled surface for mixing uniquely shaped vessels (or a handful of multiple test-tubes), the head can easily be flipped over and reattached in reverse orientation.

Like the original BenchMixer, the drive system is balanced with Q-Drive™ technology, providing a smooth vortexing action, while minimizing noise and excessive vibration. This results in quieter, more efficient and longer lasting operation. With a maximum speed up to 3,200 rpm, the mixer provides an instant vortex of even the largest sample sizes, including full 50ml tubes.

Available Accessories:

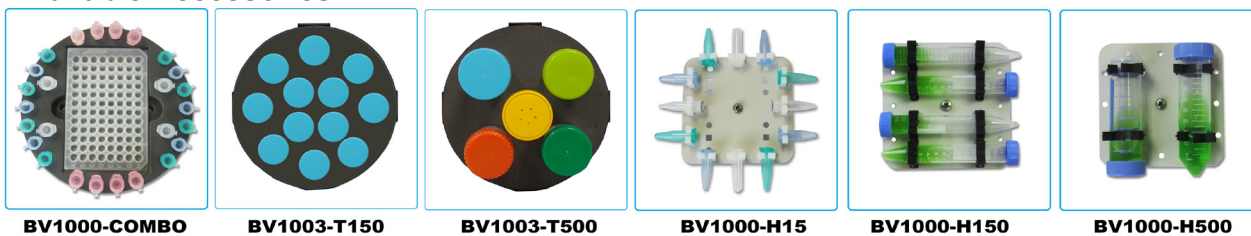

Technical Data:

| | |
|-------------------------|--|
| Speed Range: | 200 to 3,200 rpm |
| Operating Modes: | Touch or continuous |
| Orbit: | 3mm |
| Operating Temp. Range: | +4° C to +45°C |
| Dimensions: (W x D x H) | 5 x 6.3 x 6.7 in.* 13 x 16 x 17 cm |
| Weight: | 8.4 lbs (3.8kg) |
| Electrical: | 115V, 60Hz or 230V, 50Hz/60Hz, 180W |
| Warranty: | 2 Years |

*Dimensions of BV1000 model: 5.2 x 6.7 x 6.7 in./13 x 17 x 17 cm

Ordering Information:

| Item No. | Description: |
|--------------|---|
| BV1003* | BenchMixer V2 Vortexer (with reversible head) |
| BV1000* | BenchMixer Vortexer (original) with standard cup head |
| BV1000-FLAT | Optional 3 in. flat head attachment (for BV1000 only) |
| BV1000-COMBO | Optional combination head for tubes and microplates (38x1.5/2.0ml & 28x0.5ml or one microplate) |
| BV1003-T150 | Optional head for 12 x 15ml tubes (BV1003 only) |
| BV1003-T500 | Optional head for 5 x 50ml tubes (BV1003 only) |
| BV1000-H15 | Optional head for 12 x 1.5/2.0ml, horizontal |
| BV1000-H150 | Optional head for 4 x 15ml tubes, horizontal |
| BV1000-H500 | Optional head for 2 x 50ml tubes, horizontal |



*115V with US plug. For 230V/50Hz with EU plug, please add (-E). For 230V/60Hz with EU plug, please add (-E2).



- ✦ The only vortexer available with **Multi-Head™**
- ✦ Powerful motor for **INSTANT** vortexing
- ✦ **Q-Drive™** dynamic balancing system
- ✦ Variable speed from 200 to 3,200 rpm



Unique Multi-Head allows for standard vortexing, **PLUS** holds up to 8 microtubes

Available Accessories:

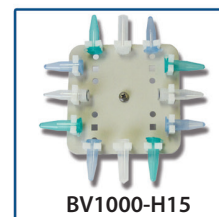

The Mortexer™ is MORE than your standard vortex mixer. The unique design of the Multi-Head™ (included) features a traditional cup head for general purpose mixing, plus holds up to eight microcentrifuge tubes. The drive system is balanced with Q-Drive™ technology, providing a smooth vortexing action, while minimizing noise and excessive vibration. This results in quieter, more efficient and longer lasting operation.

Other features include: “no-walk” suction feet, cold room/incubator compatibility and spill-proof electronic controls.

Technical Data:

| | |
|----------------------------|--|
| Speed Range: | 200 to 3,200 rpm |
| Operating Modes: | Touch or continuous |
| Orbit: | 3mm |
| Operating Temp. Range: | +4° C to +45° C |
| Dimensions: (W x D x H) | 5 x 6.3 x 6.7 in. 13 x 16 x 17 cm |
| Weight: | 8.4 lbs (3.8kg) |
| Electrical: | 115V, 60Hz or 230V, 50Hz*, 180W |
| Warranty: | 2 Years |

Ordering Information:

| Item No. | Description: |
|----------------|---|
| BV1005* | Mortexer Vortex Mixer (with Multi-Head) |
| BV1000-FLAT | Optional 3 inch flat head attachment |
| BV1000-COMBO | Optional combination head for tubes and microplates (38x1.5/2.0ml & 28 x 0.5ml or one microplate) |
| BV1000-H15 | Optional head for 12 x 1.5/2.0ml, horizontal |
| BV1000-H150 | Optional head for 4 x 15ml tubes, horizontal |
| BV1000-H500 | Optional head for 2 x 50ml tubes, horizontal |

*115V with US plug. For 230V/50Hz with EU plug, please add (-E). For 230V/60Hz with EU plug, please add (-E2).



BenchMixer™ XL Multi-Tube Vortex Mixer

BENCHMIXER™ XL MULTI-TUBE VORTEXER



CE

- + Hands free, high capacity vortexing
- + Up to 2500rpm, a true vortex in every tube
- + Pulsing function for interval vortexing
- + Wide assortment of accessories for a variety of tubes and plates
- + Suitable for use with QuEChERS

Available Accessories:



50 x 1.5/2.0ml



15 x 50ml



50 x 5 or 7ml



3 x microplates



9 x 50ml Horizontal
QuEChERS

The BenchMixer™ XL is a heavy duty vortex mixer designed for hands-free mixing in tubes, flasks, vials or cylinders. It is ideal for the QuEChERS pesticide analysis method and is instantly adaptable to an exceptionally broad range of vessels, racks and applications (horizontal or vertical). The precisely balanced drive system includes an oversized motor that delivers accurate, reproducible speeds up to 2,500rpm with rattle-free operation and minimal vibration. The programmable pulsing function allows for time specific interval mixing, increasing agitation.

The 7x12 inch platform accommodates a wide variety of standard, pre-drilled tube racks (a complete listing can be found in the ordering information section below). Additionally, BenchMixer XL can easily be adapted to almost any type of vessel commonly found in the laboratory.

Using BenchMixer XL is easy; after loading the sample rack and tightening the locking knobs, select the desired speed and run time on the large digital control panel. Then, simply press "Start" and the BenchMixer XL will perform unattended mixing for up to 100 hours.

BenchMixer XL's large capacity and adaptability make it an ideal choice for the medium to high throughput laboratory.

Technical Data:

| | |
|----------------------------|--|
| Speed Range: | 500 to 2500 rpm |
| Orbit: | 3.6mm |
| Timer | 1 min. to 99hr 59 min. |
| Platform Dimensions: | 12 x 7 in. / 30 x 17.8 cm |
| Dimensions: (W x D x H) | 15 x 9.2 x 16.5 in. 38.5 x 23.5 x 42 cm |
| Weight: | 29 lbs (13kg) |
| Electrical: | Universal Voltage 100 to 240V, 50-60Hz, 60W |
| Warranty: | 2 Years |

Ordering Information:

| Item No. | Description: |
|--------------|--|
| BV1010** | BenchMixer XL Multi-Tube Vortexer, includes 50 x 12mm tube rack |
| BV1010-TST** | BenchMixer XLQ QuEChERS Shaker/Vortexer with racks for 7 x 50ml tubes held horizontally, 50 x 15ml and 50 x 1.5/2.0ml tubes (vertical) |
| BV1010-05 | Tube Rack (PP*), 96 x 0.5ml (Ø8mm) |
| BV1010-1520 | Tube Rack (PU*), 50 x 1.5/2.0ml (Ø10mm) |
| BV1010-12 | Tube Rack (PU*), 50 x 12mm (included) |
| BV1010-13 | Tube Rack (PU*), 50 x 13mm |
| BV1010-150 | Tube Rack (PU*), 50 x 15ml (Ø16.5mm) |
| BV1010-500 | Tube Rack (PU*), 15 x 50ml (Ø29mm) |
| BV1010-25 | Tube Rack (PU*), 15 x 25mm |
| BV1010-50H | Tube Rack (PU*), 9 x 50ml Horizontal (QuEChERS) |
| BV1010-MP | Rack (PP*) for up to 3 plates or 96 well microtube racks |
| BV1010-MP02 | Carrier for above, 96 x 0.2ml tubes or strips (3pk.) |

*PU: Polyurethane / PP: Polypropylene

**Includes US plug. For EU plug, please add (-E).

TubeRocker™ Fixed Speed Rocker (2D)



CE

- Ideal for tube sizes 1.5ml to 50ml
- Grooved mat properly secures tubes without the need for any tools, clamps or hardware

Technical Data:

| | |
|-------------------------|--|
| Speed Range: | Fixed, 24 rpm (230V: 20 rpm) |
| Tilt Angle: | ±30° |
| Platform Size: | 12 x 4.5 in. / 30 x 11.4 cm |
| Load Capacity: | 5 lbs (2.3kg) |
| Operating Temp. Range: | +4° C to +45° C |
| Dimensions: (W x D x H) | 13.3 x 5.5 x 4 in. / 33.6 x 13.5 x 10 cm |
| Weight: | 4 lbs (1.8kg) |
| Electrical: | 115 or 230V, 50-60Hz, 50W |
| Warranty: | 2 Years |

Ordering Information:

| Item No. | Description: |
|----------|-----------------------------|
| M2100* | TubeRocker with grooved mat |

*115V with US plug. For 230V (EU plug), please add (-E).



8 x 50ml



15 x 15ml



15 x Blood Collection Tubes
(5ml, 7ml, 10ml or 15ml)



30 x 1.5/2.0ml

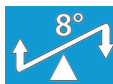

BenchBlotter™ Fixed Speed Rocker (2D)



CE



BR1000 with BR1000-STACK

- Gentle mixing for blot washing and gel staining
- Optional dual platform doubles work surface

Technical Data:

| | |
|-------------------------|--|
| Speed Range: | Fixed, 12 rpm Fixed, 10 rpm (230V) |
| Tilt Angle: | ±8° |
| Platform Size: | 12 x 12 in. / 30 x 30 cm |
| Load Capacity: | 5 lbs (2.3kg) |
| Operating Temp. Range: | +4° C to +45° C |
| Dimensions: (W x D x H) | 13.5 x 12 x 4.7 in. 34 x 30 x 12 cm |
| Stacking Clearance: | 3 in. / 7.6 cm |
| Weight: | 6.5 lbs (3kg) |
| Electrical: | 115 or 230V, 50-60Hz, 50W |
| Warranty: | 2 Years |

Ordering Information:

| Item No. | Description: |
|----------------|---|
| BR1000* | BenchBlotter Platform Rocker with flat mat |
| BR1000-STACK | Optional stacking platform with flat mat |
| BR1000-DIMPLED | Optional dimpled mat |
| B0718 | Bungee cord, used for securing vessels, pack of 4 |

*115V with US plug. For 230V (EU plug), please add (-E).



BenchRocker™ 2D Variable Speed Rocker (2D)



CE



- + Adjustable tilt & speed for a wide range of applications
- + Large 14x12" work surface
- + Safe for incubator or cold room use

The BenchRocker 2D is designed to provide the precise speeds and tilt angles required for a broad range of molecular and biological mixing applications. The user can adjust both parameters to match the vessel size and the volume of liquid being mixed, yielding optimum results.

Technical Data:

| | |
|-------------------------|--|
| Speed Range: | Variable, 2 to 30 rpm |
| Tilt Angle: | Variable, 0° to ± 30° |
| Platform Size: | 14 x 12 in. / 35 x 30 cm |
| Load Capacity: | 8 lbs (3.6kg) |
| Operating Temp. Range: | +4° C to +45° C |
| Dimensions: (W x D x H) | 14 x 12 x 8 in. 35 x 30 x 20 cm |
| Stacking Clearance: | 3 in. / 7.6 cm |
| Weight: | 7.5 lbs (3.4kg) |
| Electrical: | 115 or 230V, 50-60Hz, 50W |
| Warranty: | 2 Years |

Ordering Information:

| Item No. | Description: |
|----------------|--|
| BR2000* | BenchRocker™ 2D Rocker with flat mat |
| BR2000-STACK | Optional stacking platform (3") with flat mat |
| BR1000-DIMPLED | Optional dimpled mat |
| B0718 | Bungee cord, used for securing vessels, pack of 4 |
| BR2000-SP | STACK-PLUS Extender set, adds 1.25" clearance to stacking platform |

*115V with US plug. For 230V (EU plug), please add (-E).



Everlast™ 247 Heavy Duty - Variable Speed Rocker (2D)

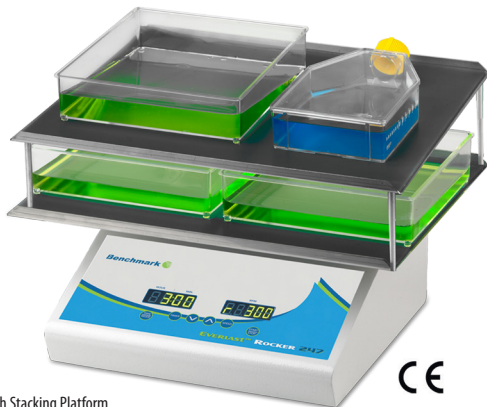

CE

- + Everlast™ 5 year warranty
- + Extra-large, 16 x 12" surface
- + 12 lb, load capacity
- + Safe for incubator or cold room use

With an unprecedented 5 year limited warranty, Benchmark's Everlast 247 Rocker is built to last. Twenty four hours a day, seven days a week . . . No problem! The powerful motor and heavy-duty drive system remain reliable and consistent, even under constant usage in a cold room or incubator.

The rocking speed and tilt angle can easily be adjusted to vary between gentle and aggressive agitation. An optional stacking platform is available four doubling the work surface.

Pictured with Stacking Platform (BR5000-STACK)

Technical Data:

| | |
|-------------------------|---|
| Speed Range: | Variable, 5 to 80 rpm |
| Tilt Angle: | Adjustable, 6° to ± 22° |
| Timer: | 1 min. to 100 hrs., increments by 1 min. or continuous |
| Platform Size: | 16 x 12 in. / 40.5 x 30 cm |
| Load Capacity: | 12lbs (5.45kg) |
| Operating Temp. Range: | +0° C to +50° C |
| Dimensions: (W x D x H) | 16 x 13.5 x 8 in. 34.2 x 40.6 x 20.3 cm |
| Stacking Clearance: | 3.5 in. / 8.9cm |
| Weight: | 20 lbs (9kg) |
| Electrical: | 115 or 230V, 50-60Hz, 50W |
| Warranty: | 5 Years |

Ordering Information:

| Item No. | Description: |
|--------------|--|
| BR5000* | Everlast™ 247 Rocker with flat mat |
| BR5000-STACK | Optional stacking platform with flat mat with 3.5" clearance |
| B0718 | Bungee cord, used for securing vessels, pack of 4 |

*115V with US plug. For 230V (EU plug), please add (-E).

BlotBoy™ Low Speed Gyrotory Rockers (3D)

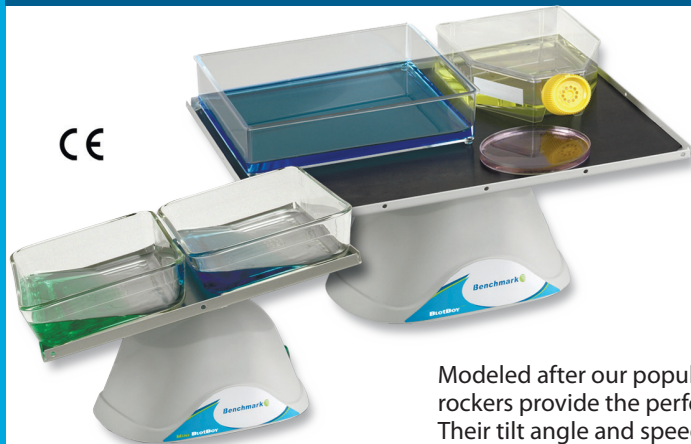

- Optimized speed & tilt for blotting, washing and staining
- Tri-directional motion for thorough, gentle mixing
- Cold room and incubator safe

Modeled after our popular BioMixer™ series of “nutating” shakers, these platform rockers provide the perfect 3-dimensional motion for all blot related applications. Their tilt angle and speed have been optimally set for gentle, but thorough mixing in gel trays, boxes and other flat vessels.

Technical Data:

| | |
|--------------------------|---|
| Speed Range: | Fixed, 12 rpm (230V: 10rpm) |
| Tilt Angle: | Fixed, ±8° |
| Platform Size (B3D1008): | 10.5 x 7.5 in. / 27 x 19 cm |
| Platform Size (B3D1308): | 12 x 12 in. / 30 x 30 cm |
| Load Capacity: | 4 lbs (1.8kg) |
| Operating Temp. Range: | +4° C to +50° C |
| Dimensions: (W x D x H) | 10.5 x 7.5 x 8 in. / 27 x 19 x 20 cm 12 x 12 x 8 in. / 30 x 30 x 20 cm |
| Weight: | 4.4 lb s (2kg) |
| Electrical: | 115 or 230V, 50-60Hz, 50W |
| Warranty: | 2 Years |

Ordering Information:

| Item No. | Description: |
|----------------|---|
| B3D1008* | Mini BlotBoy with flat mat (10.5 x 7.5")* |
| B3D1308* | BlotBoy with flat mat (12 x 12")* |
| B3D-DIMPLED | Dimpled mat (10.5 x 7.5") for B3D1008 |
| BR1000-DIMPLED | Dimpled mat (12 x 12") for B3D1308 |
| B0718 | Bungee cord, used for securing vessels, pack of 4 |

*115V with US plug. For 230V (EU plug), please add (-E).



BioMixer™ Nutating Mixer (3D)



- Includes dimpled mat; perfect for mixing blood & centrifuge tubes
- Tri-directional motion for thorough, uniform mixing

These multi-functional shakers provide a 3-dimensional “nutating” motion for thorough, foam-free mixing in blood and centrifuge tubes, as well as in a variety of flat vessels.

Ordering Information:

| Item No. | Description: |
|-------------|---|
| B3D1020* | Mini BioMixer with dimpled mat (10.5x7.5") |
| B3D1320* | BioMixer with dimpled mat (12x12") |
| B3D-FLAT | Flat mat (10.5 x 7.5") for B3D1020 |
| BR1000-FLAT | Flat mat (12 x 12") for B3D1320 |
| B0718 | Bungee cord, used for securing vessels, pack of 4 |

Technical Data:

| | |
|---------------------------|--|
| Speed Range: | Fixed, 24 rpm (230V: 20rpm) |
| Tilt Angle: | Fixed, ±20° |
| Platform Size: (B3D1020): | 10.5 x 7.5 in. / 27 x 19 cm |
| Platform Size: (B3D1320): | 12 x 12 in. / 30 x 30 cm |
| Load Capacity: | 4 lbs (1.8kg) |
| Operating Temp. Range: | +4° C to +50° C |
| Dimensions (W x D x H) | 10.5 x 7.5 x 8 in. / 27 x 19 x 20 cm Mini BioMixer BioMixer 12 x 12 x 8 in. / 30 x 30 x 20 cm |
| Weight: | 4.4 lb s (2kg) |
| Electrical: | 115 or 230V, 50-60Hz, 50W |
| Warranty: | 2 Years |



BenchRocker™ 3D Gyrotory Rocker (3D)

with
**INSTA
TILT™**



- + Adjustable speed & tilt for a wide range of applications
- + Large 12x12" work surface
- + Insta-TILT™ technology for instant adjustment of tilt angle
- + Cold room and incubator safe



Optional Stacking Platform (clearance: 3")

The BenchRocker 3D is designed to provide the precise speeds and tilt angles required for a broad range of molecular and biological mixing applications. The user can adjust both parameters to match the vessel size and the volume of liquid being mixed, yielding optimum results. Proprietary Insta-Tilt™ technology means no tools, no disassembly. *Simply grip the platform with two hands and move to the desired position.*

This model includes both flat and dimpled (autoclavable) mats for mixing a wide variety of tubes and other vessels. A stacking platforms can be purchased as an accessory, effectively doubling the usable surface area.

BenchRocker 3D features a maintenance free, brushless motor, capable of loads up to 5 lbs and is safe for use in cold rooms and incubators.

Technical Data:

| | |
|------------------------|--|
| Speed Range: | Variable, 2 to 30 rpm |
| Tilt Angle: | Variable, 0 to ± 30° |
| Platform Size: | 12 x 12 in. / 30 x 30 cm |
| Load Capacity: | 5 lbs (2.3kg) |
| Operating Temp. Range: | +4°C to +45°C |
| Dimensions: (WxDxH) | 12 x 12 x 8 in. 30 x 30 x 20 cm |
| Stacking Clearance: | 3 in. / 7.6 cm |
| Weight: | 7.5 lbs (3.4kg) |
| Electrical: | 115 or 230V, 50-60Hz, 50W |
| Warranty: | 2 Years |

Ordering Information:

| Item No. | Description: |
|----------------|--|
| B3D2300* | BenchRocker 3D with flat and dimpled mats (12x12") |
| BR1000-STACK | Stacking platform (3" clearance) with flat mat (12x12") |
| BR1000-STACK-D | Stacking platform (3" clearance) with dimpled mat (12x12") |
| B0718 | Bungee cord, used for securing vessels, pack of 4 |
| BR2000-SP | STACK-PLUS Extender set, adds 1.25" clearance to stacking platform |

*115V with US plug. For 230V (EU plug), please add (-E).

BenchWaver™ Undulating Rocker (3D)



CE

BENCHWAVER™

- ✦ Undulating, 3-dimensional motion
- ✦ Adjustable speed and tilt
- ✦ Large, 13 inch platform
- ✦ Ideal for staining, washing and general mixing

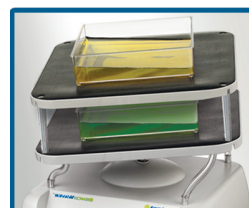

B3D5000 with B3D5000-STK



B3D5000 with B3D5000-DIMP

The BenchWaver™ combines the basic rocking motion of traditional platform rockers with the circular motion of an orbital shaker. This combination is ideal for generating the optimum 3-dimensional “undulating” motion commonly preferred for molecular biology applications.

The tilt angle is instantly adjustable (no tools or disassembly required) from 0 to 10° and the mixing speed can be adjusted from 5 to 105 rpm, using the large, user-friendly LCD control panel. Combined control of both parameters (tilt and speed) makes the BenchWaver a versatile workhorse that can provide anything from gentle, slow moving waves to a rapid, more vigorous motion. Additionally, time of operation can be selected from 1 minute up to 99 hours or for continuous operation.

The large 13.5 x 13 inch platform is supplied complete with a non-slip, rubber mat. An optional stacking platform is available for users requiring additional mixing capacity. The BenchWaver is a reliable and versatile instrument and can be used in refrigerated or incubated environments from 2° to 60°C.

Technical Data:

| | |
|----------------------------|---|
| Speed Range: | Variable, 5 to 105 rpm |
| Tilt Angle: | Variable, 0 to ± 10° |
| Platform Size: | 13.5 x 13 in. / 34 x 33 cm |
| Load Capacity: | 20 lbs (9kg) |
| Operating Temp. Range: | +4°C to +60°C |
| Dimensions: (W x D x H) | 13 x 13.5 x 9.75 in. 33 x 34 x 24.75 cm |
| Stacking Clearance: | 4.5 in. / 7.6 cm |
| Weight: | 12 lbs (5.5kg) |
| Electrical: | Universal Voltage: 100 to 240V, 50-60Hz, 50W |
| Warranty: | 2 Years |

Ordering Information:

| Item No. | Description: |
|--------------|--|
| B3D5000* | BenchWaver with platform and flat mat |
| B3D5000-STK | Optional stacking platform (4.5" clearance) with flat mat (13.5x13") |
| B3D5000-DIMP | Optional dimpled mat (13.5x13") |

*Includes US plug. For EU plug, please add (-E).



Orbi-Blotter™ Low Speed Orbital Shaker

ORBi-BLOTTER™

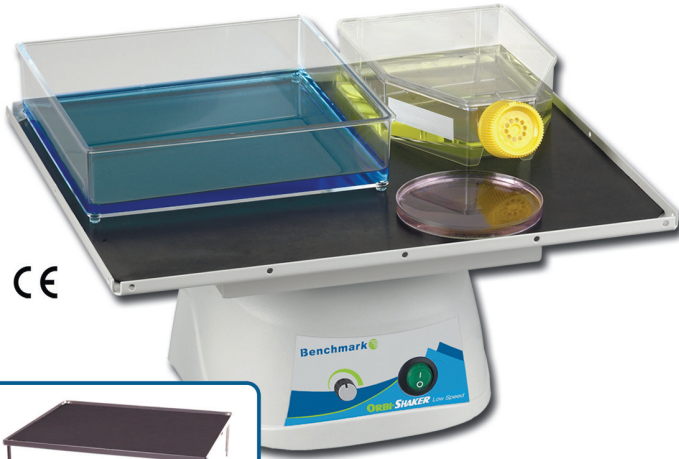

CE

- + Gentle orbital motion for gel applications
- + Large 14 x 12 in. work surface
- + Incubator and cold room safe
- + Variable speed control, 3 to 70 rpm



Optional Stacking Platform (Clearance 3")

The Orbi-Blotter™ features a gentle orbital motion with speed control down to as little as 3 rpm, making it the ideal orbital choice for low speed applications, such as blotting, washing, staining/destaining, etc. A large 14x12 in. work surface is included along with a non-slip rubber mat for holding trays, dishes, plates and other flat vessels.

An optional stacking platform can be purchased as an accessory, effectively doubling the usable work surface. The maintenance free, brushless motor is capable of loads up to 4kg and is safe for use in cold rooms and incubators.

Technical Data:

| | |
|----------------------------|--|
| Speed Range: | Variable, 3 to 70 rpm |
| Motion / Orbit: | Orbital / 19mm |
| Load Capacity: | 3 x 2L or 9 lbs (4kg) |
| Platform Size: | 14 x 12 in. / 35 x 30 cm |
| Operating Temp. Range: | +4°C to +45°C |
| Dimensions: (W x D x H) | 14 x 12 x 8 in. 35.5 x 30.5 x 20 cm |
| Stacking Clearance: | 3 in. / 7.6 cm |
| Weight: | 7.5 lbs (3.4kg) |
| Electrical: | 115 or 230V, 50-60Hz, 50W |
| Warranty: | 2 Years |

Ordering Information:

| Item No. | Description: |
|--------------|--|
| BT30* | Orbi-Blotter™ Low Speed Orbital Shaker |
| BR2000-STACK | Stacking platform with 14 x 12" flat mat (3" clearance) |
| BR2000-SP | STACK-PLUS Extender set, adds 1.25" clearance to stacking platform |

*115V with US plug. For 230v (EU plug), please add (-E).

Benchmotion™ Shaker Selection App

BenchMotion Shaker Selection App



Available on:
Get it on Google play
Available on the App Store



Scan me

Simply download the app on your phone or mobile device, or visit www.benchmotion.com to view a video demonstration showing all of the shaking motions available from Benchmark Scientific. Once the preferred motion is identified, click or touch on the "see details" option to quickly navigate your way to the most appropriate model(s) for your application.

Orbi-Shaker™ JR. Orbital Shaker



- + Horizontally circular 19mm orbit for aeration and mixing
- + Extremely compact, perfect for low to medium capacity applications
- + Instantly exchange flask clamps with MAGIC Clamp™ accessories



CE



BT300-RB

Ordering Information:

| Item No. | Description: |
|------------|--|
| BT302* | Orbi-Shaker JR. with flat mat platform (9.5 x 8 in.) |
| H1000-MR** | MAGic Clamp™ universal platform for flasks and tubes |
| BT300-RB | Adjustable spring bar platform for unique vessel types |

*Includes US plug. For EU plug, please add (-E).

**Flask clamps and tube racks sold separately, see pg. 31 for a complete listing.

Technical Data:

| | |
|--------------------------|--|
| Speed Range: | Variable, 50 to 300 rpm |
| Speed Increment: | 10 rpm |
| Motion / Orbit: | Orbital / 19mm |
| Load Capacity: | 4 x 1L or 9 lbs (4kg) |
| Platform Size: | |
| Standard (included): | 9.5 x 8 in. / 24 x 20 cm |
| MAGic Clamp (universal): | 11.5 x 9.5 in. / 29 x 24 cm |
| Operating Temp. Range: | +4°C to +65°C |
| Timer: | 1 min. to 99hr, 59 min. / continuous |
| Dimensions: (W x D x H) | 13.1 x 11.7 x 4.7 in. / 33.3 x 29.8 x 12 cm |
| Weight: | 12 lbs (5.5kg) |
| Electrical: | Universal Voltage 100 - 240V, 50-60Hz, 250W |
| Warranty: | 2 Years |

Orbi-Shaker™ Orbital Shaker



CE

- + High capacity, 9 x 500ml, 5 x 1L or 2 x 2L
- + Circular 19mm orbit for aeration and mixing
- + Instantly exchange flask clamps with MAGIC Clamp™ accessories



Technical Data:

| | |
|----------------------------|--------------------------------------|
| Speed Range: | Variable, 30 to 300 rpm |
| Speed Increment: | 1 rpm |
| Motion / Orbit: | Orbital / 19mm |
| Load Capacity: | 5x1L or 14 lbs (6.4kg) |
| Timer: | 1 min. to 99 hr / continuous |
| Platform Size: (W x D x H) | |
| Standard (included): | 13 x 12 in. / 33 x 30 cm |
| MAGic Clamp (universal): | 14 x 12 in. / 35 x 30 cm |
| Operating Temp. Range: | +4°C to +65°C |
| Dimensions: (W x D x H) | 11 x 16.2 x 3 in. / 28 x 41 x 7.5 cm |
| Weight: | 25 lbs (11.5kg) |
| Electrical: | 115 or 230V, 50-60Hz, 200W |
| Warranty: | 2 Years |

Ordering Information:

| Item No. | Description: |
|-------------|--|
| BT3001* | Orbi-Shaker with flat mat platform (13 x 12 in.) |
| BT3000-MR** | MAGic Clamp™ universal platform for flasks and tubes |
| H1000-P-SP | Universal spring platform for unique vessel types |
| H1000-P-MP | Dedicated platform for 4 x microplates |

*115V with US plug. For 230v (EU plug), please add (-E).

**Flask clamps and tube racks sold separately, see pg. 31 for a complete listing.



Orbi-Shaker™ XL High Capacity Orbital Shaker

with **MAGiC CLAMP™**
PATENTED



CE

- + High capacity, benchtop model
- + Circular 19mm orbit for aeration and mixing
- + Instantly exchange flask clamps with MAGic Clamp™ accessories

Technical Data:

| | |
|-------------------------|--|
| Speed Range: | Variable, 30 to 300 rpm |
| Speed Increment: | 1 rpm |
| Motion / Orbit: | Orbital / 19mm |
| Load Capacity: | 5 x 2L or 9 x 1L / 65 lbs (30kg) |
| Platform Size: | 18 x 18 in. / 45 x 45 cm |
| Timer: | 1 min. to 99 hr / Continuous |
| Operating Temp. Range: | +4°C to +65°C |
| Dimensions (W x D x H): | 18.5 x 21.25 x 5 in. / 47 x 54 x 12.5 cm |
| Weight: | 64 lbs (29kg) |
| Electrical: | 120 or 230V, 50-60Hz |
| Warranty: | 2 Years |

Ordering Information:

| Item No. | Description: |
|------------|--|
| BT1011* | Orbi-Shaker XL with flat mat platform (18 x 18 in.) |
| H1010-MR** | MAGic Clamp™ platform for flasks & tubes (18 x 18 in.) |
| H1010-P-SP | Universal spring platform for unique vessel types |
| H1010-P-MP | Dedicated platform for 6 x microplates |

*115V with US plug. For 230v (EU plug), please add (-E).

**Flask clamps and tube racks sold separately, see page 31 for a complete listing.



Orbi-Shaker™ MP Microplate Shaker



CE

- + Digital speed control up to 1,500rpm
- + 3mm orbit for thorough mixing in microplates
- + Includes platform for up to four microplates
- + Mix up to 80 microtubes with optional adapter

Technical Data:

| | |
|-------------------------|--|
| Speed Range: | 200 to 1,500 rpm |
| Orbit: | 3mm |
| Max. Capacity: | Up to 4 microplates |
| Operating Temp. Range: | +4 °C to +65° C |
| Dimensions (W x D x H): | 13.1 x 11.7 x 4.7 in. 33.3 x 29.8 x 12 cm |
| Timer: | 1 min. to 99 hour / cont. |
| Weight: | 12 lbs (5.5kg) |
| Electrical: | Universal Voltage 100-240V, 50-60Hz, 250W |
| Warranty: | 2 Years |

Ordering Information:

| Item No. | Description: |
|--------------|--|
| BT1502* | Orbi-Shaker™ MP microplate shaker, includes platform for 4 microplates |
| BT1500-A1520 | Optional adapter, 20 x 1.5/2.0ml for microplate shakers |
| BT1500-A05 | Optional adapter, 20 x 0.5ml for microplate shakers |

*Includes US plug. For EU plug, please add (-E).

Orbi-Shaker™ CO₂ All Environment Shakers



CE

ORBi-SHAKER™ CO₂ Remote Controlled, All Environment Shakers

- Designed to fit and maximize capacity in most CO₂ incubators and chambers
- Remote controlled, adjust settings without disturbing the CO₂ environment
- Instantly exchange flask clamps with MAGIC Clamp™ accessories



Remote controller adjusts shaker settings from outside of the chamber and magnetically attaches to most incubators

The new Orbi-Shaker CO₂ series is designed for shaking, mixing & aeration applications in extreme environments, including CO₂ incubators. It can withstand temperatures from 0 to 65°C and humidity levels up to 100%.

To avoid contamination, unintentional release of gas or deviations from protocol, all settings are adjusted via the included remote control module. This module can be stored outside of the chamber and connects to the shaker via a flat (1mm thickness) cable, that easily passes through a port or underneath an incubator door without compromising the seal. This allows for user adjustment of run time or mixing speed without opening the chamber door(s).

The instrument is supplied with a non-slip rubber mat platform. In addition, convenient MAGIC Clamp™ platforms (of multiple sizes) are also available for use with Erlenmeyer flasks and test tube racks. The unique magnetic attachment method has been widely recognized as the easiest way to instantly change between flask clamps of different sizes.

| Compatibility Chart: | SureTherm™ CO ₂ | | New Brunswick™ | | Shel Lab® 142L & 167L | Thermo® HeraCell™ | | Fisher® IsoTemp™ 184 | VWR® Symphony™ | |
|--|----------------------------|------|----------------|-------------|--------------------------|-------------------|-----|-------------------------|----------------|------|
| | 45L | 180L | Galaxy® S41i | Galaxy® 170 | | 150 | 240 | | 5.3A | 8.5A |
| Orbi-Shaker CO ₂ (14 x 12" platform) | * | ○ | ● | ○ | ○ | ○ | ○ | ○ | ○ | ○ |
| Orbi-Shaker CO ₂ XL (16 x 16.5" platform) | N/A | ● | N/A | ● | ○ | ○ | ○ | ○ | ● | ○ |
| Orbi-Shaker CO ₂ XL (18 x 18 platform) | N/A | N/A | N/A | N/A | ● | N/A | ● | ● | N/A | ● |

* Compatible 9.5 x 11.5" (Item: H1000-MR) available

N/A
Not Compatible

○
Compatible

●
Compatible, Maximizes Capacity

| | |
|-------------------------|--|
| Speed Range: | Variable, 30 to 300 rpm |
| Speed Increment: | 1 rpm |
| Motion / Orbit: | Orbital / 19mm |
| Max. Capacity (BT4001): | 1 x 2L or 5 x 1L |
| Max. Capacity (BT4011): | 5 x 2L or 9 x 1L |
| Timer: | 1 min. to 99 hr / Continuous |
| Platform Dimensions: | |
| BT4001 (included): | 13 x 12 in. / 33 x 30 cm |
| BT4011 (included): | 16 x 16.5 in. / 40 x 42.5 cm |
| Operating Temp. Range: | 0°C to +65°C |
| Dimensions: W x D x H | |
| BT4001 Shaker: | 11.9 x 13.4 x 3.5 in. / 30 x 34 x 9 cm |
| BT4011 Shaker: | 17 x 18 x 5 in. / 43 x 45.75 x 12.7 cm |
| Weight (BT4001) | 25 lbs, (11.5kg) |
| Weight (BT4011): | 50lbs (23kg) |
| Cord Length: | 60.5 in. / 154 cm |
| Electrical: | 120 or 230V, 50-60Hz, 600W |
| Warranty: | 2 Years |

Ordering Information:

| Item No. | Description: |
|---|---|
| BT4001* | Orbi-Shaker CO ₂ w/ flat mat platform (13x12 in.) |
| BT4011* | Orbi-Shaker CO ₂ XL w/ flat mat platform (16x16.5 in.) |
| MAGIC™ Clamp Universal Platforms for flask clamps & tube racks** | |
| BT3000-MR | MAGIC Clamp™ platform (14x12 in.) for BT4001 |
| BT4010-MR | MAGIC Clamp™ platform (16x16.5 in.) for BT4011 |
| H1010-MR | MAGIC Clamp™ platform (18x18 in.) for BT4011 |
| Additional Platforms: | |
| H1000-P-SP | Universal spring platform for unique vessel types |
| H1000-P-MP | Dedicated platform for 4 x microplates |

*115V with US plug. For 230v (EU plug), please add (-E).

**Flask clamps and tube racks sold separately, see page 31 for a complete listing.

Orbi-Shaker™ Series MAGIC Clamp™ Accessories



H1000-MR-CMB Adjustable flask clamp, accepts 125ml, 250ml and 500ml Erlenmeyer flasks.
(For a video demonstration, scan the QR code above.)



Maximum Flask Capacity with MAGIC Clamp Platforms

| Item No. | Description: | Platform H1000-MR | Platform BT3000-MR | Platform H1010-MR |
|---------------|--|-------------------------------|--|---|
| | | Available For Orbi-Shaker JR. | Available For Models Orbi-Shaker & Orbi-Shaker CO ₂ | Available For Orbi-Shaker XL (CO ₂) |
| H1000-MR-CMB | NEW! Adjustable flask clamp, accepts 125, 250 & 500ml Erlenmeyer flasks | 12/8/5 | 20/14/9 | 36/25/16 |
| H1000-MR-50 | Flask clamp, 50ml Erlenmeyer flask | 20 | 30 | 49 |
| H1000-MR-125 | Flask clamp, 125ml Erlenmeyer flask | 12 | 20 | 36 |
| H1000-MR-250 | Flask clamp, 250ml Erlenmeyer flask | 8 | 14 | 25 |
| H1000-MR-500 | Flask clamp, 500ml Erlenmeyer flask | 5 | 9 | 16 |
| H1000-MR-1000 | Flask clamp, 1L Erlenmeyer flask | 4 | 5 | 9 |
| H1000-MR-2000 | Flask clamp, 2L Erlenmeyer flask | 1 | 2 | 5 |
| H1000-MR-3000 | Flask clamp, 3L (or 2.8L) Fernbach flask | N/A | 1 | 4 |

Maximum Capacity for MAGIC Clamp Platforms (Test Tube / Microplate Racks)

| Item No. | Description: | Platform H1000-MR | Platform BT3000-MR | Platform H1010-MR |
|----------------|--|-------------------------------|--|---|
| | | Available For Orbi-Shaker JR. | Available For Models Orbi-Shaker & Orbi-Shaker CO ₂ | Available For Orbi-Shaker XL (CO ₂) |
| H1000-MR-T15 | Tube Rack, 15ml conical tubes, 32 x 15ml | 2 | 3 | 8 |
| H1000-MR-T50 | Tube Rack, 50ml conical tubes, 15 x 50ml | 2 | 3 | 8 |
| H1000-MR-1550 | Combi-Tube Rack, 30 x 15ml & 20 x 50ml tubes | 2 | 2 | 4 |
| H1000-MR-T600 | Tube/Bottle Rack, 4x 500/600ml conical bottles | 1 | 2 | 4 |
| H1000-MR-T15H | Tube rack, 12 x 1.5/2.0ml tubes, horizontal | 2 | 4 | 6 |
| H1000-MR-T150H | Tube rack, 4 x 15ml tubes, horizontal | 4 | 6 | 8 |
| H1000-MR-T500H | Tube rack, 2 x 50ml tubes, horizontal | 4 | 6 | 8 |
| H1000-MR-MP | Plate rack, holds one microplate | 4 | 6 | 8 |
| H1000-MR-TSR | Angled tube rack holder (with adjustable tilt) | 2 | 6 | 8 |



Roto-Mini

- + Includes tube holders for common tube sizes
- + Available with variable speed control and advanced shaking/mixing modes:
 - + Mix (Oscillating)
 - + Pause
 - + Rock
- + Also offered with incubation (See Page 65)



Included Tube Holders:

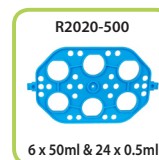

Optional Tube Holders:

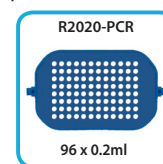

Benchmark's new Roto-Mini series of rotating mixers provides a wide range of mixing capabilities, suitable for an array of laboratory applications including resuspension, protein binding, nucleic acid purification, histochemistry, hybridization etc. The mixers include interchangeable tube holders for accommodating all common tube sizes from 0.5ml to 50ml, and the motion can be adjusted from vertical (end over end) mixing, to horizontal (rolling or hybridization style) mixing.

Roto-Mini rotators are available in the "Plus" configuration. The Plus models provide the following additional features:

- Variable speed: 5 to 70rpm
- "Mix" function: Rotating in combination w/ oscillations (increased mixing)
- "Pause" function: Rotating with intermittent "stops" during rotation
- "Rock" function: Back and forth, gentle rocking motion (see-saw)

The Plus models also offer an additional rocking platform (4.5 x 3 in.), as well as a 96 x 0.2ml tube/strip/plate holder for mixing PCR vessels in the "Mix" (oscillating) mode

Technical Data:

| | |
|-----------------------------|--|
| Speed Range: R2020: | 24rpm (230V: 20rpm) |
| R2024: | 5 to 70rpm |
| Mixing Modes: R2020: | N/A |
| R2024: | Mix, Pause & Rock |
| Max Capacity: (R2020/R2024) | 1.5/2.0ml: 44 7ml: 5 15ml: 20 50ml: 6 |
| Dimensions (R2020/R2024) | 10.8 x 6 x 6.5 in / 41 x 13.7 x 19.9cm |
| Weight: | 3 lbs/1.4 kg |
| Electrical: R2020 R2024 | 115 or 230V, 50-60Hz, 0.5A Universal Voltage 100 to 240V, 50-60Hz, 0.5A |
| Warranty: | 2 Years |

Ordering Information:

| Item No. | Description: |
|--------------------------------|---|
| R2020* | Roto-Mini Rotator with tube holders |
| R2024* | Roto-Mini Plus, Variable Speed Rotator with tube holders |
| Tube Holder Accessories | |
| R2020-1520 | Tube holder, 11 x 1.5/2.0ml, 2/pk (1 pack included) |
| R2020-0507 | Tube holder, 5 x 5-7ml, 2/pk (1 pack included) |
| R2020-150 | Tube holder, 5 x 10-15ml, 2/pk (1 pack included) |
| R2020-500 | Tube holder, 6 x 50ml, 1 each (included) |
| R2020-PCR | Tube holder, 96 x 0.2ml, 12 x PCR strips or one PCR plate** |
| R2020-RP | Mini rocking platform with rubber mat, 4.5 x 3 in. ** |

*115V with US plug. For 230v (EU plug), please add (-E).

**Accessories are recommended for "Plus" models (R2024) only



Roto-Bot™ Programmable Rotating Mixers

Roto-Bot™ PROGRAMMABLE ROTATOR

- Advanced programming with a wide variety of rotational modes
- Set for full 360° rotation, or interrupt rotations with pausing and mixing intervals
- Slow rotating to vigorous mixing
- Accepts tubes from 1.5 to 50ml
- Optional rocking platform



Motion Mode Chart:

| F1 | F2 | F3 | F4 | F5 | F6 | F7 | F8 | F9 | -- | C1 C2 | PP* | Key: |
|----|----|----|----|----|----|----|----|----|----|-------------|-----------------------|------|
| | | | | | | | | | | Custom Mode | Platform Rocking Mode | |

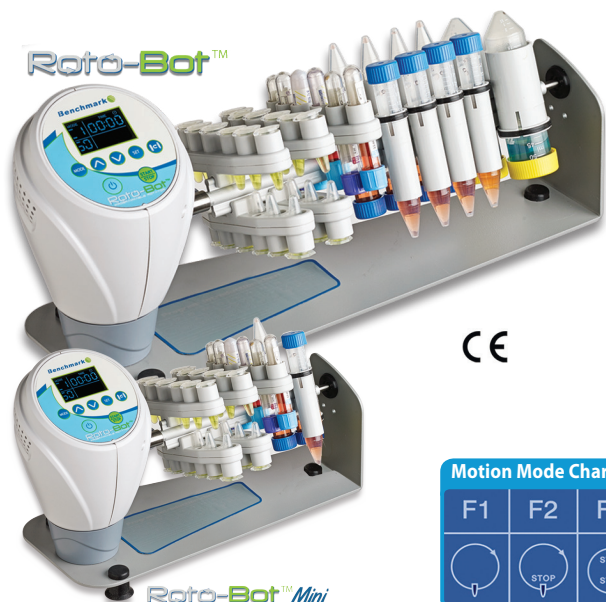

The Roto-Bot™ Rotating Mixers feature advanced programming options that far surpass that of the traditional laboratory rotator. With digital speed control and more than 10 operating modes, the Roto-Bot can be selected to perform a wide variety of rotating, mixing and vibrating actions. In addition, these actions can be combined in succession using the C1 and C2 “Custom Modes”, providing the user with a nearly infinite level of programming.

The Roto-Bot and Roto-Bot Mini each include an assortment of vertical tube holders. The Mini model is supplied with holders for 12 x 1.5ml tubes, 2 x 15ml & 2 x 50ml tubes; the standard model, 30 x 1.5/2.0ml, 8 x 15ml & 2 x 50ml tubes. For higher capacity applications, more of these holders can be purchased as accessories. The unique, sliding attachment allows for quick and easy changing of tube holders. For rocking applications, a platform with a non-slip mat is available. Once attached, simply select the “PP” mode to activate the rocking mode.

| Tube Holder Capacity & Ordering Information: | | | | | |
|--|------------|------------|------------|------------|------------|
| Item Number: | R4040-1520 | R4040-150 | R4040-500 | R4040-HZ15 | R4040-HZ50 |
| Description: | 6 x 1.5ml | 1 x 15ml | 1 x 50ml | 6 x 15ml | 6 x 50ml |
| Tube Diameter: | 10 to 13mm | 16 to 17mm | 28 to 30mm | 16 to 17mm | 28 to 30mm |
| Orientation: | Dual* | Vertical | Vertical | Horizontal | Horizontal |
| Holder Capacity (Mini/Standard): | 10 / 16 | 10 / 22 | 6 / 12 | 1 / 2 | 1 / 2 |
| Tube Capacity (Mini/Standard): | 60 / 96 | 10 / 22 | 6 / 12 | 6 / 12 | 6 / 12 |
| Package Unit: | Pack of 2 | Pack of 2 | Pack of 2 | 1 ea. | 1 ea. |

*The unique, dual attachment points of the 6 x 1.5ml holder allow for mixing in both the vertical and horizontal orientation.

Technical Data:

| | |
|------------------------|---|
| Speed Range: | 1 to 80rpm |
| Capacity (R4040): | 6 x 50ml, 10 x 15ml or 60 x 1.5ml |
| Capacity (R4045): | 12 x 50ml, 22 x 15ml or 96 x 1.5ml |
| Timer: | 1 sec. to 99 hours 59 min. / Cont. |
| Dimensions (R4040) | 11.4.x 5.4 x 7.8 in / 29 x 13.7 x 19.9cm |
| W x D x H (R4045) | 16.1.x 5.4 x 7.8 in / 41 x 13.7 x 19.9cm |
| Operating Temp. Range: | +2°C to +70°C |
| Weight: | 4 lbs/1.8 kg (R4040) / 5 lbs/2.27kg (R4045) |
| Electrical: | Universal Voltage 100 to 240V, 50-60Hz, 3A |
| Warranty: | 2 Years |

Ordering Information:

| Item No. | Description: |
|-----------|---|
| R4040* | Roto-Bot Mini with tube holder starter set Includes 6x1.5ml holders (2ea.), 1x15ml holder (2ea.) & 1x50ml holder (2ea.) |
| R4045* | Roto-Bot with with tube holder starter set Includes 6x1.5ml holders (5ea.), 1x15ml holder (8ea.) & 1x50ml holder (2ea.) |
| R4040-RP | Rocking Platform (w/ flat mat) for R4040, 6 x 5.5 in |
| R4045-RP2 | Rocking Platform (w/ flat mat) for R4045, 6 x 10 in. |

*Includes US plug. For EU plug, please add (-E).



CE

- + Adjustable speed and tilt
- + Reversing mode for increased agitation
- + Cold room and incubator safe
- + Includes three rotisseries for all common tube sizes

Included Rotisseries:



48 x 1.5/2.0ml
(48 x 10-14mm Ø tubes)



20 x 15ml
(20 x 15-20mm Ø tubes)



12 x 50ml
(12 x 25-35mm Ø tubes)

The Benchmark Rotating Mixer provides gentle to vigorous mixing of laboratory samples up to 50ml. With adjustable speed control and tilt angle, the Rotating Mixer is ideal for a variety of applications, from mixing blood samples to the preparation of homogenous dispersions.

Three rotisserie tube holders are included for mixing all common laboratory sample tubes and each individual tube holder is constructed of rubber coated steel to provide a secure grip, preventing any "wobble" or loosening during mixing at high speeds.

A unique reversing mode is selectable for more intense mixing. In reversing mode, the mixer rotates for up to 360° then stops and rotates in the reverse direction. This back and forth motion occurs repeatedly until the set time has expired.

With included accessories and unique mixing options, Benchmark's Rotating Mixer offers increased flexibility that is not commonly found with traditional laboratory rotators.

Technical Data:

| | |
|-------------------------------------|--|
| Speed: | 1 to 40rpm |
| Tilt Angle: | 0 to 90° (vertical to horizontal) |
| Capacity: | 12x50ml, 20x15ml or 48x2.0ml |
| Timer: | 1 sec. to 9 hrs or continuous |
| Exterior Dimensions: (W x D x H) | 8.25 x 10.5 x 12.5 in. 21 x 27 x 32 cm |
| Operating Temp. Range: | +4° to +65°C |
| Weight: | 7 lbs (3.2kg) |
| Electrical: | Universal Voltage 100 to 240V, 50-60Hz, 25W |
| Warranty: | 2 Years |

Ordering Information:

| Item No. | Description: |
|----------|---|
| R5010* | Benchmark Rotating Mixer, Includes three rotisserie tube holders for 1.5/2.0, 15 and 50ml tubes |

*Includes US plug. For EU plug, please add (-E).

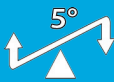

TubeRoller Tilting Tube & Bottle Roller



R3010

- + Gentle rolling motion
- + Smooth 5° tilting motion
- + Accepts tubes and bottles from 8mm to 200mm

CE

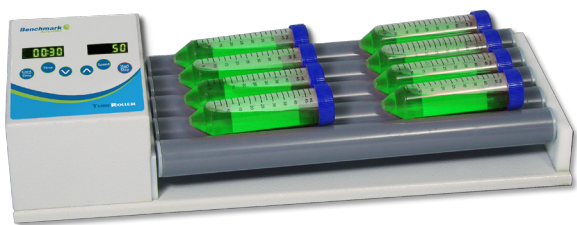

R3005

Benchmark TubeRollers are designed for the gentle, thorough mixing of a variety of containers, including Vacutainers™, bottles, test tubes, centrifuge tubes and roller bottles. Both models (5 roller and 10 roller) provide adjustable speed control up to 80 rpm, for a broad range of mixing applications.

As the roller mechanism rotates through each complete revolution, the right side of each roller is gently elevated approximately 0.5 in (13mm) and returns to the horizontal starting position. This additional, gentle up/down motion provides a “wave” effect and guarantees that the entire sample is subjected to complete, thorough mixing, end to end. This built in tilt feature provides a level of homogeneous mixing uniformity that can not be matched by any stationary roller apparatus.

From blood collection tubes to roller bottles, Benchmark TubeRollers are the ideal choice for research, clinical laboratories and doctors’ offices.

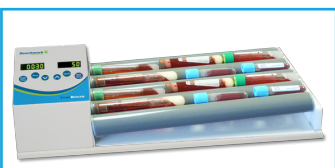
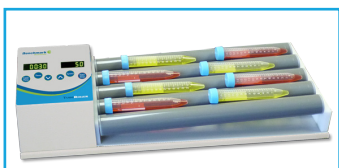

Technical Data:

| | | |
|-------------------------|------------------------------------|-------------------------------------|
| Speed: | Variable, 2 to 80rpm | |
| Motion: | Simultaneous roll & tilt (±5°) | |
| Operating Temp: | 4°C to 40°C | |
| Individual Roller Dims: | 1.2 x 12.5 in. / 3 x 32cm | |
| Vessels Accepted: | 8mm to 200mm diameter | |
| Roller Spacing: | 5mm, on 35mm centers | |
| Electrical: | 115 or 230V, 50-60Hz, 50W | |
| Load Capacity: | 2kg | 4kg |
| | R3005 | R3010 |
| Number of Rollers: | 5 | 10 |
| Dimensions (W x D x H): | 18 x 7 x 3.5 in. 45 x 18 x 9 cm | 18 x 14 x 3.5 in. 45 x 36 x 9 cm |
| Weight: | 11 lbs (5kg) | 17.6 lbs (8kg) |
| Warranty: | 2 years | 2 years |

Typical Sample Load Capacity:

| Vessel | R3005 | R3010 |
|-----------------------------------|-------|-------|
| 12 x 75mm tubes | 12 | 26 |
| 16 x 100mm tubes | 8 | 18 |
| 16 x 125mm tubes | 8 | 18 |
| 15ml screw cap tubes | 8 | 18 |
| 50ml screw cap tubes | 8 | 18 |
| 850cm ² roller bottles | 1 | 2 |

Ordering Information:

| Item No. | Description: |
|----------|----------------------------|
| R3005* | TubeRoller with 5 rollers |
| R3010* | TubeRoller with 10 rollers |

*115V with US plug. For 230V (EU plug), please add (-E).

Benchmark™ Overhead Stirrers



- ✦ LCD control panel
- ✦ Includes stand assembly and 4 arm propeller (stainless steel)
- ✦ Compact and quiet
- ✦ Digital accuracy and convenience

Ordering Information:

| Item No. | Description: |
|--------------|---|
| IPS2050-20* | Benchmark OS-20L Overhead Stirrer, 20L |
| PS2050-40* | Benchmark OS-40L Overhead Stirrer, 40L |
| IPS2050-P-S1 | One line propeller, stainless steel |
| IPS2050-P-S2 | Centrifugal impeller, stainless steel |
| IPS2050-P-S3 | Paddle with flat holes, stainless steel |
| IPS2050-P-S4 | 4 arm propeller, stainless steel |
| IPS2050-P-T1 | One line propeller, teflon |
| IPS2050-P-T2 | Centrifugal impeller, teflon |
| IPS2050-P-T3 | Paddle with flat holes, teflon |
| IPS2050-P-T4 | 4 arm propeller, teflon |

*Includes US plug. For EU plug, please add (-E).

Technical Data:

| | | |
|-------------------------------------|--|------------|
| Speed Range: | 30 to 2200 rpm | |
| Motor Type: | DC Brushless Motor | |
| Chuck Diameter Range: | 0.5 - 10mm | |
| Exterior Dims.: (W x D x H) | 7.3 x 3.3 x 8.7 in. / 18.6 x 8.3 x 22.0 cm | |
| Protection Mode: | IP42 | |
| Operating Range: | Ambient 5 - 40°C | |
| Electrical: | 115 or 230V, 50-60Hz | |
| Warranty: | 2 Years | |
| | IPS2050-20 | IPS2050-40 |
| Mixing Capacity (H ₂ O): | 20L | 40L |
| Maximum Torque: | 40Ncm | 60Ncm |
| Input Power: | 60W | 120W |
| Output Power: | 50W | 100W |
| Net Weight (Mixer): | 2.6kg | 2.8kg |
| Maximum Viscosity: | 10000mPas | 50000mPas |

Additional Stirring Products from Benchmark

MINIMAG™ Mini Magnetic Stirrer

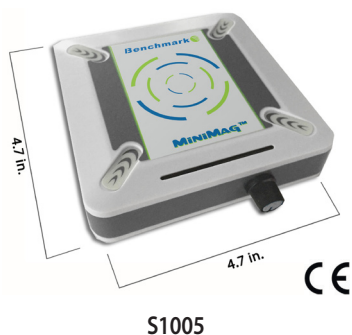

S1005

- ✦ Mini sized, less than 5 in. wide
- ✦ Adjustable speed control, 100 to 1500rpm

MHS | Series Multi-Position Hotplate Stirrers



IPS-7000

- ✦ Available in 5 and 10 position
- ✦ Provide simultaneous heating and stirring
- ✦ White ceramic top plate

HCS | Series High Capacity Stirrers



IPS-7101

- ✦ High capacity, up to 150L
- ✦ White ceramic coated top plate
- ✦ Digital speed and time control

Homogenizers



Pg. 38

D1000 **Handheld Homogenizer**



Pg. 39

BeadBug™ 3 & 6
Microtube Homogenizers



Pg. 40

BeadBlaster™ 24 & 24R
Microtube Homogenizers



Pg. 41

BeadBlaster™ 96
Ball Mill Homogenizer



Pg. 42

Pulse 150™ **Ultrasonic Homogenizer**



Pg. 42

BenchMasher™ 400 **Paddle Blender**

D1000 Homogenizer



Ergonomic, "slim-line" handle design

CE

- + Quickly homogenizes samples (in under 30 seconds)
- + For volumes 100µl to 250ml
- + Supplied with two generator probes (5mm and 7mm)

Benchmark's handheld homogenizer, the D1000, is designed to rapidly homogenize, emulsify, suspend and disrupt biological samples. Ideal for use with microtubes, the homogenizer works well with samples from 0.1ml to 250ml (depending upon the generator probe used).

The D1000 is a rotor stator homogenizer which works by drawing the sample, in liquid, into the generator probe with the variable speed rotor, and then forcing it out through the slots in the stator. This achieves mechanical shearing of the sample. As the sample is repeatedly drawn up and forced through the stator, additional shearing takes place.

A powerful, 130W motor drives the rotor at speeds from 8,500 to 30,000 rpm. Speed is continuously adjustable to meet sample processing needs. A separate on/off switch allows the homogenizer to be left at the appropriate setting.

Generator probes are available in four sizes. The 5mm and 7mm diameter have a 50mm length for use with samples in microtubes. The 10mm x 115mm probe is ideal for use with 15 and 50ml tubes and 14mm x 130mm probe, for 50ml tubes and vessels up to 250ml. The unit is supplied with one each of the 5mm and 7mm generator probes. All the generator probes are made of stainless steel and can be sterilized by autoclaving.

Available Generator Heads

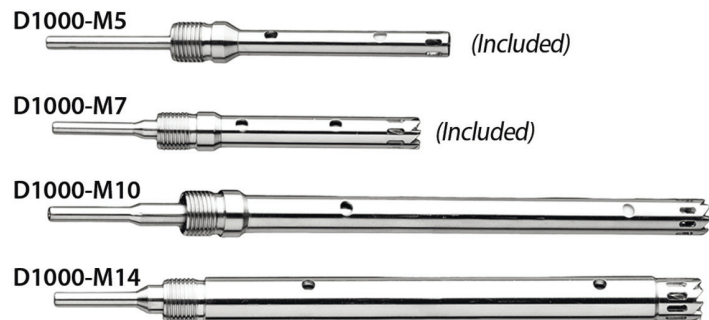

Ordering Information:

| Item No. | Description: |
|-----------------------------------|--|
| D1000 | D1000 Hand-Held Homogenizer includes one 5mm (flat-bottom) generator probe and one 7mm (saw tooth) generator probe |
| <u>Optional generator probes:</u> | |
| D1000-M10 | 10mm x 115mm saw tooth, for 15 and 50ml tubes |
| D1000-M14 | 14mm x 130mm saw tooth, for 50ml - 250ml vessels |
| D1000-M5 | 5 x 50mm for microtubes, 5pk. |
| D1000-M7 | 7 x 50mm for microtubes, 5pk. |
| D1000-ST | Stand for D1000 Homogenizer |

*115V with US plug. For 230V (EU plug), please add (-E).

Technical Data:

| | |
|--|--|
| Speed Range: | 8,500 to 30,000rpm |
| Capacity: | 0.1 to 250ml |
| Noise Level: | <70db |
| Dimensions: (W x D x H): (without probe) | 1.8 x 2.3 x 9 in. 4.5 x 5.8 x 22.5 cm |
| Weight: | 1.35 lbs (0.6kg) |
| Electrical: | 115 or 230V, 50-60Hz, 130W |
| Warranty: | 2 Years |

BeadBug™ 3 & 6 Microtube Homogenizers

BEADBUG MICROTUBE HOMOGENIZERS



- + Extremely powerful mixing action for lysis, grinding or homogenization
- + Eliminates the cross contamination associated with hand-held homogenizers
- + Faster & more effective than tissue grinders
- + Process multiple tubes simultaneously

The BeadBugs™ are high energy benchtop homogenizers that set the performance standard for personal sized cell disruption and lysis instruments. Simultaneous homogenization of up to 6 samples takes place (often within 45 seconds) inside the disposable 2ml screw cap microtubes. The optimized mixing motion causes rapid cell disruption through constant high velocity impacts from the hardened micro-beads chosen specifically for your sample type.

Developed for samples too tough to be homogenized in a common lab vortexer, the BeadBugs provide a convenient and economical alternative to larger and more expensive homogenizers on the market today. With compact footprints (as small as 7 x 8", in the 3 position model), the Beadbugs are the ideal homogenizing instruments for low to medium throughput laboratories.



BeadBug 3, accepts 3 x 2.0ml



BeadBug 6, accepts 6 x 2.0ml



Video Demonstration



Benchmark offers a wide range of homogenization beads (including glass, zirconium, stainless steel, etc.)

Ordering Information:

| Item No. | Description: |
|-----------------------------|--|
| D1030* | BeadBug™ 3, Three Position Microtube Homogenizer |
| D1036* | BeadBug™ 6, Six Position Microtube Homogenizer |
| D1036-A5 | Optional tube holder 2 x 5ml screw cap tubes (for D1036 only) |
| Prefilled Tube Kits: | Include 2.0ml non-skirted screw cap tubes with caps, sealing rings and beads as specified below: |
| D1031-01 | Standard glass beads, Ø 0.1mm, 50pk. |
| D1031-05 | Standard glass beads, Ø 0.5mm, 50pk. |
| D1031-10 | Standard glass beads, Ø 1.0mm, 50pk. |
| D1032-01 | Triple-Pure™, high impact zirconium beads, Ø 0.1mm, 50pk. |
| D1032-05 | Triple-Pure™, high impact zirconium beads, Ø 0.5mm, 50pk. |
| D1032-10 | Triple-Pure™, high impact zirconium beads, Ø 1.0mm, 50pk. |
| D1032-15 | Triple-Pure™, high impact zirconium beads, Ø 1.5mm, 50pk. |
| D1032-30 | Triple-Pure™, high impact zirconium beads, Ø 3.0mm, 50pk. |
| D1032-60 | One ceria zirconium oxide satellite, Ø 6.0mm, 50pk. |
| D1032-SK | Starter Kit, 10 ea. of Ø 0.1, 0.5, 1.0, 1.5 & 3.0 Triple-Pure™ zirconium |
| D1033-28 | Stainless steel beads, Ø 2.8mm, 50pk. |
| D1033-30G | Garnet shards with 1 zirconium bead Ø 6.0mm, 50pk. |
| D1034-MX | Mixed format, 0.1mm silica, 1.4mm zirconium, 4mm silica, 50pk. |
| D1031-T20 | Empty tubes (2.0ml) pack of 1000 |
| D1031-RFS | Reinforced empty tubes (2.0ml) pack of 600 |

*115V with US plug. For 230V (EU plug), please add (-E).

Additional bead types are also available (in both bulk and prefilled kits). Please contact Benchmark for a complete listing.

Technical Data:

| | |
|----------------------------|---|
| Speed Range: | 2,800 to 4,000rpm (D1030) 2,500 to 4,350rpm (D1036) |
| Max. Capacity: | 3 x 2.0ml non-skirted (D1030) 6 x 2.0ml (skirted or non) or 2 x 5ml (D1036) |
| Timer: | 3 sec. to 3 min. (D1030) 1 sec to 90 sec. with up to 10 cycles (D1036) |
| Operating Temp. Range: | +4° C to +45° C (ambient temp.) |
| Dimensions: (W x D x H) | 6.9 x 8.3 x 5.3 in. / 17 x 21 x 13.5 cm (D1030) 8.6 x 14 x 8 in. / 22 x 35.5 x 20.5 cm (D1036) |
| Weight: | 5 lbs (2.2kg) / 20 lbs (9kg) |
| Electrical: | 115 or 230V, 50-60Hz, 50W (D1030) 100 to 240V, 50-60Hz, 145W (D1036) |
| Warranty: | 2 Years |

BeadBlaster™ 24 and 24R Microtube Homogenizers



CE

- + Fast, efficient homogenization, usually in 35 seconds or less
- + For all sample types, from soft tissue to bone
- + High throughput, up to 24 samples
- + True refrigeration - no external connections, dry ice or liquid nitrogen (D2400-R model only)

The BeadBlaster™ 24 completely lyses, grinds and homogenizes a broad variety of biological samples. Even the most difficult and resistant samples are fully homogenized, often in 35 seconds or less. The stainless steel tube carrier subjects up to 24 samples to an optimized, high speed, 3D motion, producing high energy impacts between the samples and micro-beads to release cellular contents. To protect heat sensitive samples, the unit can be digitally programmed to operate in shortened consecutive cycles with a rest period in between.

Benchmark offers an assortment of prefilled tube kits for a variety of sample types. The popular Triple-Pure™ kits include acid washed, heat treated, zirconium beads. The beads are tested to be free of nucleases, making them ideal for molecular biology applications. A convenient starter kit (D1032-SK) is available to accommodate a broad range of samples and optimize applications.



Stainless steel, 24 position tube carrier



Video Demonstration



Ordering Information:

Technical Data:

| | |
|-------------------------|---|
| Speed: | 4.00 to 7.00 m/s (2430 to 4260rpm) |
| Speed Increments: | 0.05 m/s |
| Capacity: | 24 x 2.0ml tubes or 12 x 5ml |
| Cycle Time: | 1 to 90 sec. (1 sec. increments) |
| Pause Between Cycles: | 0 to 2 min. (1 sec. increments) |
| Max Cycles Per Program: | 10 |
| Program Memory: | 50 |
| Accel/Decel: | <2 sec. / <2 sec., D2400 <4 sec. / <4 sec., D2400-R |
| Noise Level: | <68 db, D2400 <65 db, D2400-R |
| Cooling Method: | Compressor, D2400-R |
| Precool Ambient to 0°C | <30 minutes, D2400-R |
| Operating Temp. Range: | +4 °C to +65°C |
| Temp. Range: | -10°C to ambient, D2400-R |
| Dimensions: (WxDxH) | 11 x 14.2 x 15.2 in. / 28 x 36 x 38.5cm, D2400 12.6 x 20.1 x 16.2 in. / 32 x 51 x 41cm, D2400-R |
| Weight: | 55 lbs (25kg), D2400 88 lbs (40kg), D2400-R |
| Electrical: | Universal Voltage 100V to 240V, 50-60Hz, 600W, D2400 100V to 240V, 50-60Hz, 1000W, D2400-R |
| Warranty: | 2 Years |

| Item No. | Description: |
|-----------------------------|---|
| D2400* | BeadBlaster™ 24 Microtube Homogenizer with 24 x 2.0ml tube holder |
| D2400-R* | BeadBlaster™ 24 Refrigerated Microtube Homogenizer with 24 x 2.0ml tube holder |
| D2400-R5V2 | Optional tube holder, 12 x 5ml |
| Prefilled Tube Kits: | Include 2.0ml non-skirted screw cap tubes with caps, sealing rings and beads as specified below: |
| D1031-01 | Standard glass beads, Ø 0.1mm, 50pk. |
| D1031-05 | Standard glass beads, Ø 0.5mm, 50pk. |
| D1031-10 | Standard glass beads, Ø 1.0mm, 50pk. |
| D1032-01 | Triple-Pure™, high impact zirconium beads, Ø 0.1mm, 50pk. |
| D1032-05 | Triple-Pure™, high impact zirconium beads, Ø 0.5mm, 50pk. |
| D1032-10 | Triple-Pure™, high impact zirconium beads, Ø 1.0mm, 50pk. |
| D1032-15 | Triple-Pure™, high impact zirconium beads, Ø 1.5mm, 50pk. |
| D1032-30 | Triple-Pure™, high impact zirconium beads, Ø 3.0mm, 50pk. |
| D1032-SK | Starter Kit, 10 ea. of Ø 0.1, 0.5, 1.0, 1.5 & 3.0 Triple-Pure™, high impact zirconium |
| D1032-60 | One ceria zirconium oxide satellite, Ø 6.0mm, 50pk. |
| D1033-28 | Stainless steel beads, Ø 2.8mm, 50pk. |
| D1033-30G | Garnet shards with 1 zirconium bead Ø 6.0mm, 50pk. |
| D1034-MX | Mixed format, 0.1mm silica, 1.4mm zirconium, 4mm silica, 50pk. |
| D1031-T20 | Empty tubes (2.0ml) pack of 1000 |
| D1031-RFS | Reinforced empty tubes (2.0ml) pack of 600 |
| D1034-28 | 5ml tubes with stainless beads, Ø 2.8mm, 50pk. |

Additional bead types are also available (in both bulk and prefilled kits). Please contact Benchmark for a complete listing.

*Includes US plug. For EU plug, please add (-E).

BeadBlaster™ 96 Ball Mill Homogenizer

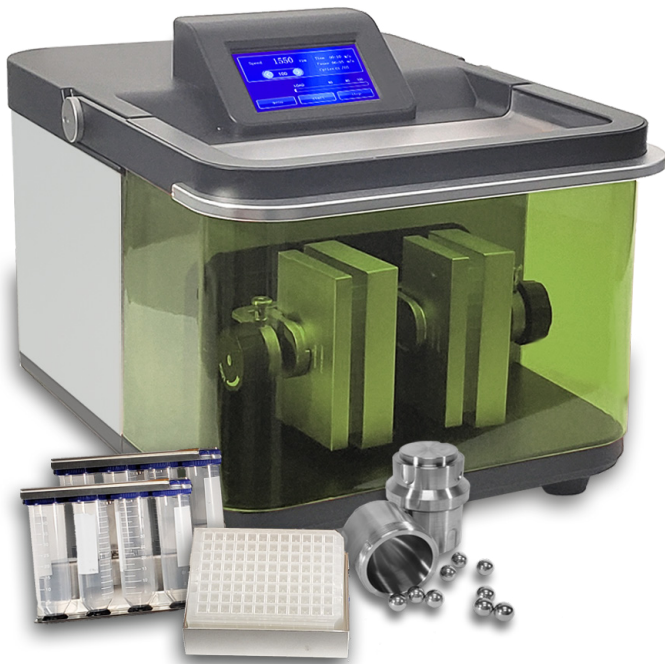

- + Rapid cell lysis for extraction of DNA, RNA and proteins in plates and microtubes
- + Fine grinding of cannabis/hemp samples
- + Able to homogenize bone, teeth and other hard samples
- + Homogenize/blend powders and suspensions

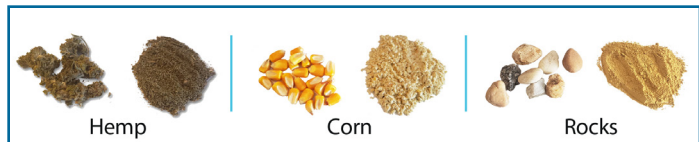

Ordering Information:

| Item No. | Description: |
|---------------------------------|--|
| IPD9600* | BeadBlaster™ 96 Ball Mill Homogenizer for plates, tubes and jars |
| Accessories: | All accessories ordered separately. |
| Microplates: | |
| IPD9600-96 | Adapter for 96 well plates, set of 2, required for processing microplates |
| IPD1196-40 | 96 well plate, 2ml, prefilled w/4mm balls, with sealing mat, 10pk. |
| IPD1196-MP | 96 well plate, 2ml, square well, 10pk. |
| IPD1196-CM | EVA cap mat for above plate, 10pk. |
| IPD9600-BD28 | 96 well ball dropper for 2.8mm balls |
| IPD9600-BD4 | 96 well ball dropper for 4mm balls |
| IPD9600-BD5 | 96 well ball dropper for 5mm balls |
| D1133-28 | 2.8mm stainless steel balls, 1000pk. |
| Microtubes: | |
| IPD9600-1520 | Adapter for 32x2ml tubes, PTFE, set of 2, requires use of IPD9600-96 |
| IPD9600-96A2 | Rack for 20x2ml tubes, set of 2, requires use of IPD9600-96 |
| IPD9600-96 | Adapter for microplates and tube holders, set of 2 |
| D1032-SK | Starter kit of TriplePure™ Prefilled Bead Tubes, 10 tubes each, prefilled with 0.1, 0.5, 1.0, 1.5 and 3.0mm diameter beads, certified nuclease and protease free |
| 50mL Tubes: | |
| IPD9600-50T | Adapter for 4 x 15/50ml tubes, set of 2 |
| IPD9600-3858-1 | Ceramic homogenizers w/angled ends, 3/8" x 5/8", pk of 100 |
| IPD9600-3878-1 | Ceramic homogenizers w/angled ends, 3/8" x 7/8", pk of 100 |
| Grinding Jars and Balls: | |
| IPD9600-25S | Stainless steel jar, 25ml, set of 2 |
| IPD9600-10BS | Stainless steel grinding ball, 10mm, 500g |
| IPD9600-50BS | Stainless steel jar, 50ml, set of 2 |
| IPD9600-25BS | Stainless steel grinding ball, 25mm, 500g |
| IPD9600-25TC | Tungsten carbide jar, 25ml, set of 2 |
| IPD9600-10TCB | Tungsten carbide grinding ball, 10mm, each |
| IPD9600-35ZO | Zirconium oxide jar, 35ml, set of 2 |
| IPD9600-15ZOB | Zirconium oxide grinding ball, 15mm, each |
| IPD9600-35PTFE | PTFE grinding jar, 35ml, set of 2 |
| IPD9600-15PTFB | PTFE grinding ball, steel core, 15mm, each |
| IPD9600-CK | Cryo Kit, includes bucket, gloves, goggles and tongs, for use with liquid nitrogen |

Technical Data:

| | |
|-------------------------|--|
| Speed: | 0.00 to 0.00 m/s (180 to 1800rpm) |
| Speed Increments: | 100rpm |
| Capacity: | 2 microplates, 8 x 50ml tubes, 64 x 2ml tubes |
| Cycle Time: | 1 sec. to 59min.: 59 sec. (1 sec. increments) |
| Pause Between Cycles: | 1 sec. to 59min.: 59 sec. (1 sec. increments) |
| Max Cycles Per Program: | 99 |
| Program Memory: | 9 |
| Feed Size: | <10mm |
| Final Fineness*: | <5µm |
| Operating Temp. Range: | +4°C to +40°C (ambient temp.) |
| Dimensions: (W x D x H) | 13.2 x 19.7 x 14.4 in. / 33.5 x 50 x 36.6 cm |
| Weight: | 141 lbs (64kg) |
| Electrical: | Universal Voltage 120V to 220V, 50-60Hz, 200W, 6A |
| Warranty: | 2 Years |

*Dependent on sample material and grinding configuration

Additional bead types are also available (in both bulk and prefilled kits). Please contact Benchmark for a complete listing.

*Includes US plug. For EU plug, please add (-E).

Pulse 150 Ultrasonic Homogenizer

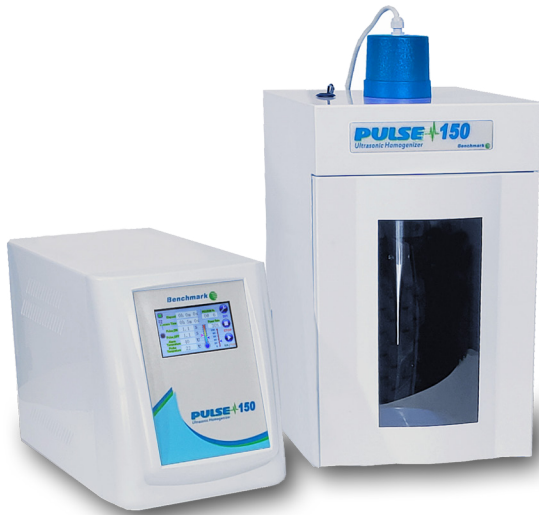

- + Ideal for cell disruption, DNA shearing and ChIP assays
- + Programmable with touch screen control and pulsed operation
- + 150W, for volumes 0.1 to 150ml (requires appropriate horn)
- + Supplied complete with 6mm horn, temperature probe and soundproof enclosure

Technical Data:

| | |
|--------------------------------------|--|
| Power: | 1.5 - 150W, continuously adjustable |
| Frequency: | 20 - 25kHz |
| Cycle Time (pulse on/off): | 0.1 - 99.9 sec. |
| Timer: | 1 sec. - 99 hrs.: 59 min., 59 sec. |
| Duty Cycle: | 0.1 - 99.9% |
| Volume*: | 0.1 - 150ml |
| Program Memory: | 20 programs |
| Display/Control: | 4.3 in. full color touch screen |
| Horn: | 6mm titanium (others available) |
| Alarms: | no load, over load, end of run, over temp. |
| Controller: (W x D x H) | 12 x 18.5 x 16.9 in. / 30.5 x 47 x 43cm |
| Controller Weight: | 35.3 lbs (16kg) |
| Soundproof Enclosure: (W x D x H) | 13.8 x 13.8 x 21.7 in. / 35 x 35 x 55cm |
| Soundproof Enclosure weight: | 22 lbs (10kg) |
| Electrical: | 120V or 230V, 50-60 Hz |
| Warranty: | 2 years |

*Volume dependent upon the installed horn. Supplied with 6mm horn for volumes 10 - 100ml.

The Pulse 150™ Ultrasonic Homogenizer uses cavitation and ultrasonic waves to break cells in suspension, shear DNA and prepare samples for ChIP assays. With up to 150 watts of power, the unit can process samples from 0.1ml to 150ml.

All components needed for homogenization are included with the Pulse 150 - a controller, transducer, temperature probe, 6mm diameter titanium alloy horn and wrenches to change horns. A soundproof box with sample platform is also supplied as standard. The box helps to reduce the noise generated by the sonicator.

Ordering Information:

| Item No. | Description: |
|----------|---|
| DP0150* | Pulse 150 Ultrasonic Homogenizer, complete with controller, transducer, 6mm horn and soundproof enclosure |
| DP0150-2 | Horn, 2mm diameter, for 0.1 - 5ml |
| DP0150-3 | Horn, 3mm diameter, for 3 - 10ml |
| DP0150-6 | Horn, 6mm diameter, for 10 - 100ml (included) |
| DP0150-8 | Horn, 8mm diameter, for 25 - 150ml |

*115V with US plug. For EU plug, please add -E to cat no.

BenchMasher™ 400



- + Contamination free homogenizing of large samples
- + Adjustable stroke length
- + Built in UV light for chamber decontamination
- + Touch screen control with variable mixing speed and temperature up to 65°C
- + Ideal for recovery of intact microorganisms in food and environmental samples

Ordering Information:

| Item No. | Description: |
|----------------|--|
| IPD4400* | BenchMasher™ 400 Paddle Blender |
| IPD4400-B400 | 400ml x 60µm, 300 x 180mm, 500pk. |
| IPD4400-B400F1 | 400ml x 70µm with lateral (side) nylon filter, 300 x 190mm, 500pk. |
| IPD4400-B400F2 | 400ml x 70µm with full nylon filter, 300 x 190mm, 500pk. |

*115V with US plug. For EU plug, please add -E to cat no.

Thorough sample homogenization



Autoclaves and Sterilization



Pg. 44

MicroBead Sterilizers
& UV Clave™ Ultraviolet Chamber



Pg. 45

BactiZapper™ MicroSterilizer Series



Pg. 46

BioClave™ 8 & 18 Benchtop Autoclave



Pg. 47

BioClave™ 28 Benchtop Autoclave

MicroBead Bead Sterilizer



- + Digital control up to 300°C
- + Quickly sterilizes forceps, needles & other laboratory tools
- + Eliminates the danger associated with open flames

Ordering Information:

| Item No. | Description: |
|------------|---|
| B1201* | MicroBead Sterilizer with beads (150g) |
| B1202 | MicroBead Sterilizer TALL with Beads (300g) |
| B1201-BEAD | Extra glass beads, 1000g |

*115V with US plug. For 230V (EU plug), please add (-E).

Technical Data:

| | |
|----------------------------------|--|
| Temperature Range: | 100°C to 300°C |
| Preheat Time: | Approx. 25 min. (to 300°C) |
| Chamber Diameter: | 40mm |
| Chamber Height: | 80mm (B1201) / 140mm (B1202) |
| Bead Capacity: | 150g (B1201) / 300g (B1202) |
| External Dimensions: (W x D x H) | 5.5 x 5.7 x 6.1 in. / 14.5 x 15.5 x 15.5cm 5.5 x 5.7 x 8.5 in. / 14.5 x 15.5 x 21.5cm |
| Weight: | 4.4 lbs (2 kg) / 5.5 lbs (2.5kg) |
| Electrical: | 115 or 230V, 50-60Hz 120W (B1201) / 250W (B1202) |
| Warranty: | 1 Year* |

*Excludes heating element

UV Clave™ Ultraviolet Chamber



- + Improves quality of PCR research by reducing potential contaminants
- + Multiple lamps and reflective chamber walls provide true 360° irradiation
- + Proprietary UVC transparent shelf, eliminates potential for missed coverage (blind spots)
- + Inactivates DNA, RNA, viruses & bacteria on PCR vessels

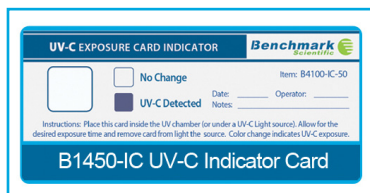

Ordering Information:

| Item No. | Description: |
|-------------|--|
| B1450* | UV Clave™ Ultraviolet chamber |
| B1450-IC | UV-C indicator card (double sided), 1/pk. |
| B1450-ISS | UV-C indicator stickers (0.5 x 0.5 in.), 1/pk. |
| B1450-SH | Optional wire shelf |
| B1450-SH-UV | Optional UVC transparent shelf |

*115V with US plug. For 230V (EU plug), please add (-E).

Technical Data:

| | |
|-----------------|---|
| UV Bulbs: | 6 x 4W |
| UV Wavelength: | 254nm |
| UV Intensity: | +500µW/cm ² (center of chamber) |
| UV Dosage: | 600mJ/cm ² (20 min cycle) |
| UV Timer: | 5-20 min. (5 min. increments) |
| Heater Time: | 30-120 min. (30 min. increments) |
| Heater Temp.: | 55°C |
| Internal Dims.: | 8.5x10.1x12.2 in. / 21.6x25.6x31.8cm |
| External Dims.: | 11.5x10.5x15.7 in. / 29.2x26.7x40cm |
| Max. Height: | 30cm |
| Shelf Dims.: | 10 x 8 in. / 25.4 x 20.3cm |
| Shelf Material: | 2 Stainless steel wire / 1 UV-C transparent |
| Weight: | 11 lbs. (5 kg) |
| Electrical: | 120V 60Hz or 230V 50Hz - 110W |
| Warranty: | 2 Years |



BactiZapper™ MicroSterilizer Series



- + Complete sterilization in 5-7 seconds
- + Safe, convenient and no spatter
- + Ideal for platinum loops, needles and glass tube mouths

The BactiZapper™ Classic has an asbestos-free core element to produce ultra high temperatures (815°C /1500°F), sterilizing many microorganisms within 5-7 seconds. Well-proven technology provides instant sterilization of platinum inoculating loops, needles, pipette mouths and various metal & borosilicate glass instruments used in quality control and research.

The ceramic heating element is safely enclosed in a perforated stainless steel guard chamber, protecting users from accidental contact with the extreme temperatures of the core area. Compact and convenient, the BactiZapper can be used in anaerobic and aerobic chambers.

The BactiZapper™ TILT Series utilizes the same well-proven technology of our original BactiZapper Classic, but with a unique, adjustable head angle that allows for more convenient sterilization. The "XL" model offers an increased chamber diameter of 35mm, making this product more suitable for the sterilization of larger objects.

Bacti-Zapper Tilt

- + Adjustable tilt angle, for more ergonomic inoculation (reduces hand fatigue)
- + Same convenient operation as popular "Classic" model
- + Available as "XL", with wide chamber for sterilizing large vessels (tubes, flask mouths, etc.)

Ordering Information:

| Item No. | Description: |
|-----------|--|
| B1000* | BactiZapper Classic MicroSterilizer |
| B1001* | BactiZapper TILT Micro-Sterilizer with adjustable tilt angle |
| B1001-XL* | BactiZapper TILT XL Micro-Sterilizer, 35mm chamber & adjust tilt angle |
| B1000-01 | Loop holder attachment (B1001 only) |
| B1000-03 | Slide dryer attachment, 3 slides (B1001 only) |
| B1000-RA | Replacement heating element, 115V |
| B1000-RAE | Replacement heating element, 230V |

*115V with US plug. For 230V (EU plug), please add (-E).



Adjustable Angle (55°)

35mm chamber for tubes, flask/bottle necks, etc.

Technical Data:

| Model: | Bacti-Zapper Classic | Bacti-Zapper TILT | Bacti-Zapper TILT XL |
|----------------------------------|---|--------------------------------------|--------------------------------------|
| Max Temperature: | 815°C / 1500°F | 815°C / 1500°F | 815°C / 1500°F |
| Sterilization Time: | 5-7 seconds | 5-7 seconds | 5-7 seconds |
| Chamber Diameter: | 0.55 in./14mm | 0.55 in./14mm | 1.38 in./35mm |
| Chamber Length: | 6 in./153mm | 6.2 in./157mm | 3.95 in./100mm |
| External Dimensions: (W x D x H) | 4 x 6 x 6.5 in. 10.2 x 15.2 x 16.5cm | 4 x 6 x 10 in. 10.2 x 15.2 x 26cm | 4 x 6 x 11 in. 10.2 x 15.2 x 28cm |
| Electrical Data: | 120V or 230V, 50-60 Hz | 120V or 230V, 50-60 Hz | 120V or 230V, 50-60 Hz |
| Weight: | 2.9 lbs./1.3kg | 3.4 lbs./1.5kg | 3.5 lbs./1.6kg |
| Warranty: | 1 Year* | 1 Year* | 1 Year* |

*Excludes heating element

BactiZapper Tilt XL

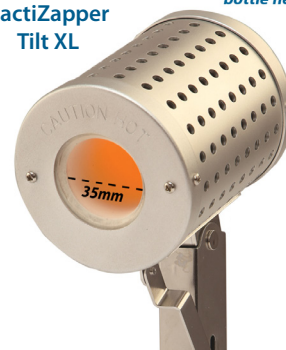



B4000-M

B4000-18

- + Fully automatic, just press “start”
- + Rapid, complete sterilization
- + Internal memory for retrieving cycle date
- + Extremely compact

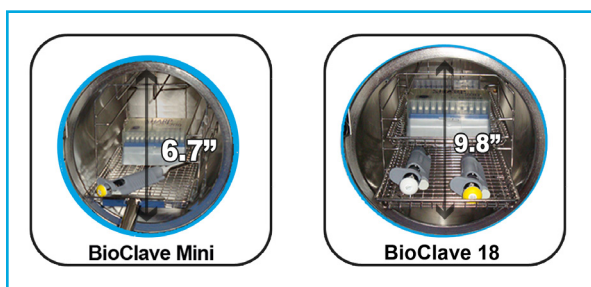

| Bottle/Flask Capacity | B4000-M | B4000-18 |
|------------------------|---------|----------|
| 100ml Media Bottle | 8 | 15 |
| 250ml Media Bottle | 4 | 8 |
| 500ml Media Bottle | N/A | 3 |
| 125ml Erlenmeyer Flask | 4 | 8 |
| 250ml Erlenmeyer Flask | 2 | 6 |
| 500ml Erlenmeyer Flask | N/A | 3 |

Ordering Information:

| Item No. | Description: |
|-----------|---------------------------------|
| B4000-M* | BioClave Mini Autoclave (8L) |
| B4000-18* | BioClave Autoclave (18L) |
| B4000-P* | Printer for BioClave series |
| B4000-PA | Extra roll of paper for B4000-P |

*115V with US plug. For 230V (EU plug), please add (-E).
This product is intended for research use only.

Despite the space-saving exterior dimensions of the BioClaves, the stainless steel sterilization chambers are surprisingly large, accommodating a variety of liquids, media, instruments, glassware, plasticware and other common laboratory items. Both of these benchtop models include a mechanical and electrical safety interlock that prevents the door from being opened until the pressure has been released.

With large digital displays and fully automatic operation, all segments of the sterilization cycle (fill, sterilize, exhaust and dry) commence and run to completion by simply pressing the start button. An optional thermal mini-printer is also available for providing a record of sterilization parameters. In addition, a built in USB port allows for transfer of these parameters to a computer for printing or storage of cycle data.

Both BioClaves offer three cycle options (standard programs), which are preset for the sterilization of liquids, wrapped instruments or unwrapped instruments/plasticware. A fourth option “Dry Only” is also available for additional drying time to be added to the end of a cycle. For special applications requiring variations in cycle parameters, all settings on the BioClaves are fully adjustable.

Technical Data:

| B4000-M (BioClave Mini) | |
|----------------------------------|--|
| Chamber Volume: | 8L |
| Max. Pressure: | 29 PSI / 2 Bar |
| Chamber Dimensions: | 6.7 x 12.5 in. / 17 x 31cm |
| Tray Dimensions: | 5.11 x 10.43 in. / 13 x 26.5cm |
| Exterior Dimensions: (W x D x H) | 20 x 13.5 x 12.9 in. 51 x 34 x 33 cm |
| Weight: | 74 lbs (33kg) |
| Electrical: | 115 or 230V, 50-60Hz, 950W |
| Warranty: | 1 Year |
| B4000-18 (BioClave 18) | |
| Chamber Volume: | 18L |
| Max. Pressure: | 29 PSI / 2 Bar |
| Chamber Dimensions: | 9.8 x 13.77 in. / 24.8 x 35cm |
| Tray Dimensions: | 7.5 x 11.2 in. / 19 x 28.4cm |
| Exterior Dimensions: (W x D x H) | 22 x 17.5 x 15.7 in. 56 x 44.5 x 40cm |
| Weight: | 89 lbs (40kg) |
| Electrical: | 115 or 230V, 50-60Hz, 1600W |
| Warranty: | 1 Year |

BioClave™ 28 Research Autoclave

BioCLAVE™ 28
RESEARCH AUTOCLAVE



- + Accepts bottles/flasks up to 2L
- + Fully automatic, just press start
- + Adjustable sterilization times
- + USB port for digital documentation of records
- + Built in water tank, does not require connection to an external water supply

With similar operation to the BioClave Mini and BioClave 18, the 28 liter model features an increased chamber size with a diameter of 32cm. With this larger internal chamber, the BioClave 28 capable of sterilizing 1 and 2 liter flasks and bottles.

Despite the increased chamber size, the unit is still relatively compact, suitable for benchtop use. Operation is fully automatic, meaning all segments of operation (fill, sterilize, exhaust and dry) commence and run to completion by simply pressing "Start". An optional thermal mini-printer is available for providing a record of sterilization parameters. In addition, a built in USB port allows for transfer of these parameters to a computer for printing or storage of cycle data.

All BioClaves offer three cycle options (standard programs), which are preset for the sterilization of liquids, wrapped instruments or unwrapped instruments/plasticware. A "Dry Only" option is also available for additional drying time to be added to the end of a cycle. For special applications requiring variations in cycle parameters, the cycle times are fully adjustable.

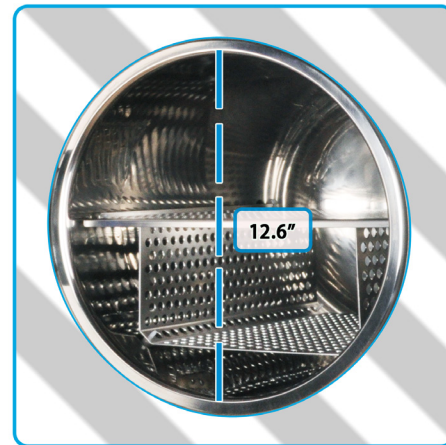

| Bottle/Flask Capacity | B4000-28 |
|------------------------|----------|
| 100ml Media Bottle | 42 |
| 250ml Media Bottle | 11 |
| 500ml Media Bottle | 8 |
| 1L Media Bottle | 6 |
| 2L Media Bottle | 2 |
| 125ml Erlenmeyer Flask | 30 |
| 250ml Erlenmeyer Flask | 8 |
| 500ml Erlenmeyer Flask | 6 |
| 1L Erlenmeyer Flask | 3 |
| 2L Erlenmeyer Flask | 2 |

Ordering Information:

| Item No. | Description: |
|--------------|--|
| B4000-28-120 | BioClave Autoclave (28L), 120V |
| B4000-28-220 | BioClave Autoclave (28L), 220V |
| B4000-P | Printer for BioClave series |
| B4000-PA | Extra roll of paper for B4000-P, 3/pk. |

This product is intended for research use only.

Technical Data:

| B4000-28 (BioClave) | |
|-------------------------------------|---|
| Chamber Volume: | 28L |
| Max. Pressure: | 30.5 PSI / 2 Bar |
| Chamber Dimensions: | 12.6 x 16.4 in. 32 x 41.7 cm |
| Exterior Dimensions: (W x D x H) | 25 x 25 x 22 in. 63.5 x 63.5 x 55.9cm |
| Weight: | 209 lbs (95kg) |
| Electrical: | 115 or 230V 50-60Hz, (220V accepts 208 to 240V), 2300W |
| Warranty: | 1 Year |

Temperature Control Equipment

Pg. 50



Benchmark™ Hotplates & Stirrers

Pg. 51



myTemp™ Mini Incubators

Pg. 52



SureTemp™
Bi-Convection Incubators

Pg. 53



myTemp™ 65HC Incubator (heating & cooling)

Pg. 54



myTemp™ Mini CO₂ Incubator

Pg. 55



ST-Series & ST-Series PLUS
CO₂ Incubators

Pg. 56-58



myBlock™ and isoBlock™
Dry Baths

Pg. 59



myBath™ Water Baths





Pg. 60

BeadBath Duo™ Digital Bead Baths



Pg. 61

SB-12L Shaking Water Bath



Pg. 62

Incu-Shaker™ Mini Shaking Incubator



Pg. 63

IncuShaker™ 10L Shaking Incubators



Pg. 64

IncuShaker™ Mini CO2 Shaking Incubator



Pg. 65

Roto-Therm™ Mini Incubated Rotator



Pg. 66

MultiTherm™ Heating/Cooling Vortexers



Pg. 67

Thermal Cycler Series



Digital Hotplates, Stirrers & Hotplate Stirrers



CE

- + Large white ceramic top plate
- + Safety LED indicates hot surface
- + Available with stir capacities up to 15L
- + Control actual sample temperature (with optional probe)



H3770-S

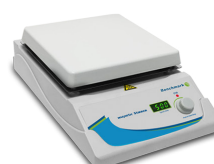

H3770-H



H3770-HS



H3710-S

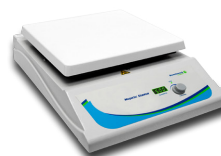

H3710-H



H3710-HS

Benchmark Scientific Hotplates and Stirrers provide reliable performance and safe operation for everyday laboratory use. With two sizes (7" or 10") to choose from, each model features a durable, chemical resistant, white ceramic top plate and advanced microprocessor controls. The constant monitoring system provides precise control of temperature with rapid heating and faster boiling times (heating models only). In addition, the powerful motor drive system of the magnetic stirrer ensures efficient mixing in larger vessels and more viscous samples.

Temperature and/or mixing speed can be viewed at all times on the large digital display and a safety LED illuminates when the top plate temperature exceeds 50°C. An optional external temperature probe can be used for applications that require precise temperature control. The probe provides direct feedback to the microprocessor with adjustments for maintaining the selected sample temperature within $\pm 1^\circ\text{C}$. An optional clamp assembly (H3770-CS) is available for mounting thermometers, temperature probes, etc.

Technical Data:

| | |
|-------------------------|--|
| Speed Range | 150 to 1500rpm* |
| Temp. Range | Ambient +5° to 400 °C* |
| Warranty: | 2 Years |
| H3770 (7 x 7) | |
| Platform: | 7 x 7 in. / 17.8 x 17.8 cm |
| Max Stir Capacity: | 5L |
| Dimensions: (W x D x H) | 7.5 x 11.5 x 4 in. / 18 x 27.9 x 10.1 cm |
| Weight: | 8 lbs (3.6kg) |
| Electrical: | 115V or 230V, 50-60 Hz, 850W |
| H3710 (10 x 10) | |
| Platform: | 10 x 10 in. / 25.4 x 25.4 cm |
| Max Stir Capacity: | 15L |
| Dimensions: (W x D x H) | 11.6 x 16.7 x 4.5 in. / 29.5 x 42.4 x 11.4 cm |
| Weight: | 8 lbs (3.6kg) |
| Electrical: | 115V or 230V, 50-60 Hz, 1500W |

* Speed and temperature adjustments available only on relevant models

Ordering Information:

| Item No. | Description: |
|-----------|---|
| H3770-H* | Benchmark Digital Hotplate, 7 x 7" |
| H3770-S* | Benchmark Digital Magnetic Stirrer, 7 x 7" |
| H3770-HS* | Benchmark Digital Hotplate Stirrer, 7 x 7" |
| H3710-H* | Benchmark Digital Hotplate, 10 x 10" |
| H3710-S* | Benchmark Digital Magnetic Stirrer, 10 x 10" |
| H3710-HS* | Benchmark Digital Hotplate Stirrer, 10 x 10" |
| H3770-ROD | Optional support rod |
| H3770-TP | Optional temperature probe |
| H3770-CS | Clamp assembly with support rod and clamps for securing thermometers/probes |

*115V with US plug. For 230V (EU plug), please add (-E).

myTemp™ Mini Digital Incubators (20L)

myTEMP™ Mini Digital Incubators



- + Digital temperature control, with in-lab calibration
- + Personal sized, 13 x 14.5 in. footprint
- + Two models
 - Heat only
 - Heat & cool

CE

With digital temperature control, the myTemp incubators provide convenient “set and walk away” operation, eliminating the need for external thermometers and repetitive “fine tuning” of an analog control knob. Simply choose the desired temperature and the incubators quickly begin to heat (or cool in the -HC model only). Throughout the incubation, the chamber temperature is constantly monitored and displayed in real time on the large LED control panel.

Despite a modest footprint of 14.5 x 13”, the myTemp incubators feature large internal chambers, capable of accepting flasks and bottles up to 2 liters. The chamber temperature is accurately maintained with a unique airflow design that utilizes multiple internal fans, resulting in a high level of uniformity.

The incubators include two adjustable/removable shelves for increased capacity. A mini nutating rocker (supplied with both flat and dimpled mats) is also available for agitation of samples during incubation and can plug directly into the included internal power outlet.

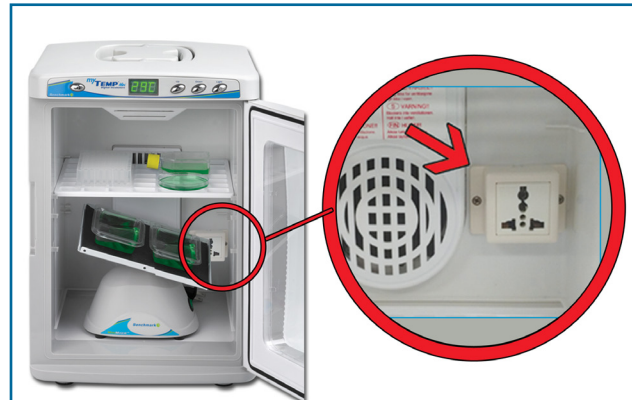

myTemp Mini shown with H3D1020
(Rocker plugs directly into the internal power outlet)

Technical Data:

| | |
|-------------------------|--|
| Temp. Range | |
| H2200-H: | Ambient +5° to 60°C |
| H2200-HC: | Ambient -15° to 60°C |
| Temp. Accuracy: | ± 0.5°C (at 37°C) |
| Temp. Increments: | 1°C |
| Temp. Uniformity: | ± 1.5°C (at 37°C) |
| Capacity: | 20L or 0.8 cu. ft. |
| Dimensions: (W x D x H) | |
| Interior: | 10.3 x 9.3 x 12.9 in. / 26 x 23.5 x 33 cm |
| Exterior: | 13.2 x 14.5 x 18.7 in. / 33.5 x 37 x 48 cm |
| Weight: | 15 lbs (6.8kg) |
| Electrical: | Universal Voltage 100 to 240V, 50-60Hz, 70W |
| Warranty: | 2 Years |

Ordering Information:

| Item No. | Description: |
|------------|--|
| H2200-H* | myTemp Mini Digital Incubator, includes 2 shelves, (heat only, ambient +5° to 60°C) |
| H2200-HC* | myTemp Mini Digital Incubator, includes 2 shelves, (heat & cool, ambient -15° to 60°C) |
| H3D-1020 | Mini nutating rocker, 6 x 8” platform, 115V |
| H3D-1020-E | Mini nutating rocker, 6 x 8” platform, 230V |
| H2200-SH | Extra shelf, 10.5 x 8” plastic (not autoclavable) |

*Includes US plug. For EU plug, please add (-E).

SureTemp™ Precision Incubators (40L, 70L and 130L)



SURETEMP™

Dual-Convection Incubators with SureCheck™ Data Logging

- + Precision temperature control up to 75°C
- + Dual-Convection- user adjustable to gravity or mechanical convection
- + Stainless steel internal chamber
- + Internal power outlet for shakers, mixers, etc.
- + SureCheck™ data logging port and software



The new SureTemp Incubator series provides the highest level of temperature control with uniformity and stability levels that are unmatched by competitive models in the same price class.

Each incubator is equipped with the SureCheck™ data logging system for verification of chamber temperature. The SureCheck system records temperature data points as often as every 60 seconds and stores this information on a flash drive. The data can then be viewed and saved using the included the SureCheck software. The recorded data can also be used to draw a temperature graph or exported to excel for further analysis or manipulation.

Unlike the vast majority of laboratory incubators, the SureTemp series offers “Dual-Convection” technology, allowing users to choose between mechanical convection mode (for exceptional uniformity) or gravity convection mode (for longer incubations where drying of plates may be an issue). Heating elements are strategically located on all sides of the chamber and contents can be viewed with the separate inner glass door without disrupting the temperature environment.

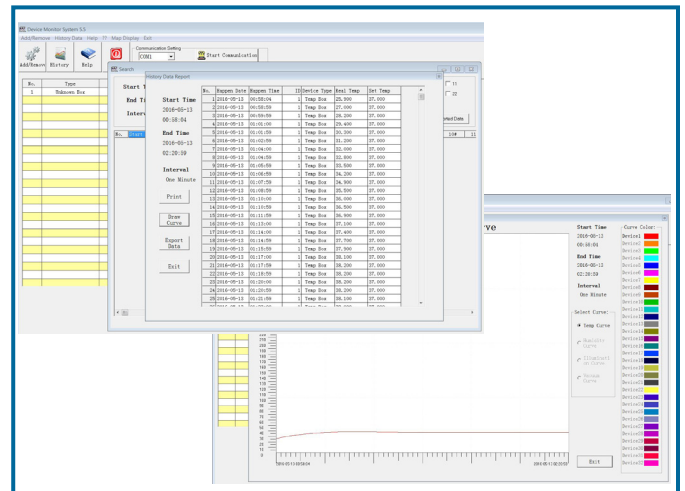

Included SureCheck™ Software: View/save recorded temperatures

Technical Data:

| | |
|---------------------|--|
| Temp. Range: | Ambient +5°C to 75°C |
| Temp. Accuracy: | ± 0.25°C* |
| Temp. Uniformity: | ± 0.25°C* |
| Temp. Stability: | ± 0.1°C* |
| Temp. Increments: | 0.1°C |
| Dimensions: (WxDxH) | Exterior |
| H2505-40 | 22.4 x 23.3 x 22.8 in. / 57 x 59.2 x 58 cm |
| H2505-70 | 26.4 x 23.3 x 26.8 in. / 67 x 59.2 x 68 cm |
| H2505-130 | 30.3 x 27.2 x 30.7 in. / 77 x 69.2 x 78 cm |
| | Interior |
| H2505-40 (40L) | 13.7 x 13.7 x 13.7 in. / 35 x 35 x 35 cm |
| H2505-70 (70L) | 17.7 x 13.7 x 17.7 in. / 45 x 35 x 45 cm |
| H2505-130 (130L) | 21.7 x 17.7 x 21.7 in. / 55 x 45 x 55 cm |
| Weight: | H2505-40: 42kg, -70: 62kg, -130: 70kg |
| Electrical: | 120V, 60Hz or 230V, 50Hz (420W, 520W, 670W) |
| Warranty: | 2 years |



SureCheck data logging port

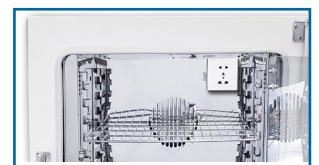

Internal power outlet

Ordering Information:

| Item No. | Description: |
|-------------|---|
| H2505-40* | SureTemp Dual-Convection Incubator with SureCheck data logging software, 40L, 115V |
| H2505-70* | SureTemp Dual-Convection Incubator with SureCheck data logging software, 70L, 115V |
| H2505-130* | SureTemp Dual-convection Incubator with SureCheck data logging software, 130L, 115V |
| H2505-40SH | Extra shelf, stainless steel for H2505-40 |
| H2505-70SH | Extra shelf, stainless steel for H2505-70 |
| H2505-130SH | Extra shelf, stainless steel for H2505-130 |

* 115V with US plug. For 230V (EU plug), please add (-E).

* Specification provided with a set temperature of 37°C

myTemp 65HC™ Heating and Cooling Incubator

myTEMP™ 65HC

Precision, Heating & Cooling Incubator



One model for
**HEATING &
COOLING**

- + Accurate temperature control from 0°C to 60°C
- + Powerful compressor, maintains 0°C
- + Stainless steel chamber
- + Internal power outlet for shakers, mixers, etc.
- + Sized for floor standing use or on bench-tops less than 32" high

CE

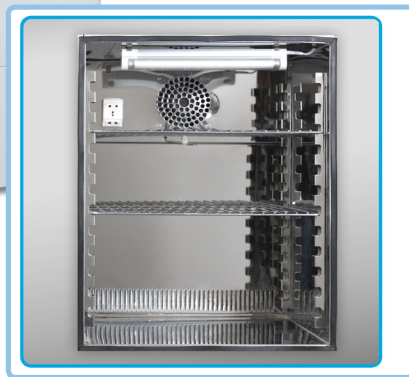

Stainless steel chamber with internal outlet & light

The myTemp 65HC Incubator is designed to provide accurate and uniform temperature control from 0° to 60°C. The broad temperature range of the instrument expands the use of this incubator to both heating and cooling applications.

A large, digital display allows for visualization of the chamber temperature and the remaining incubation time, while an internal light is included for improved visualization of the chamber. In addition, a built in, internal outlet can be used to provide power to small instruments, such as shakers, rockers, etc.

Forced air technology and stainless steel inner construction ensure uniform heat transfer throughout the chamber. When set for sub-ambient temperatures, the powerful compressor is activated, quickly cooling the chamber to the desired temperature.

With an exterior height of 39 inches (100cm), the incubator is designed to be floor-standing, yet is also compact enough for bench use. (Not recommended for use on benchtops higher than 32"/81cm). The instrument is supplied with two, adjustable height shelves, while additional shelves can also be purchased separately (item: H2265-SH).

Technical Data:

| | |
|-------------------|---|
| Temp. Range: | 0° to 60°C (Ambient -25°C to 60°C) |
| Temp. Accuracy: | 0.5°C (at 37°C) |
| Temp. Uniformity: | ±1.0.°C (at 37°C) |
| Temp. Increments: | 0.1°C |
| Dimensions: | |
| Exterior: | 21.25 x 21 x 39.35 in. |
| (W x D x H) | 54 x 53.34 x 99.85 cm |
| Interior: | 15.75 x 12.75 x 19.75 in. |
| (W x D x H) | 40 x 32.4 x 50.2 cm |
| Timer: | 1 min. to 99 hr.: 59 min. |
| Capacity: | 65L or 2.3 cubic feet |
| Weight: | 117 lbs (53kg) |
| Electrical: | 115V, 60Hz or 230V, 50Hz, 385W |
| Warranty: | 2 years |

Ordering Information:

| Item No. | Description: |
|-----------|---|
| H2265-HC* | myTemp 65 Heating and Cooling Incubator, includes two stainless steel shelves |
| H2265-SH | Extra shelf, stainless steel |

*115V with US plug. For 230V (EU plug), please add (-E).

myTemp™ Mini CO₂ Digital Incubators (20L)

myTEMP^{Mini} CO₂



- + Ideal for cell culture
- + Digital temperature control
- + Personal sized, 13 x 14.5 in. footprint
- + Dual beam IR sensor for fast response time and accurate control over CO₂ percentage



CE

At only 13 inches wide, the myTemp Mini CO₂ is the smallest and most economical incubator for culturing cells in a CO₂ environment. Its small footprint makes the incubator ideal for use inside of biological safety cabinets, isolating sensitive cultures or conserving bench space in the laboratory. With a thick layer of high efficiency insulation surrounding the chamber, the incubator is also ideal for transportation of cells. Once power has been disconnected, the incubator maintains temperature levels within 10% of the set parameter for up to 1 hour. In addition each model includes a 12V vehicle power adapter for operating the instrument in a car, boat, etc.

Both temperature and CO₂ percentage are digitally adjustable and displayed in real time on the large LED control panel. This panel also features a "Cal" function, for easy in-lab calibration of the temperature or CO₂. In addition, humidity (up to 80%) can be added to the chamber by inserting the included, stainless steel humidity reservoir.

To protect fragile samples, the CO₂ level is constantly monitored using dual beam infrared sensing technology. In the event of a drop in CO₂, audible and visual alarms are triggered, notifying the user of the error.

Despite its small size, the incubator features a relatively large 20L chamber with the capacity for flasks and bottles up to 2 liters. Two removable, stainless-steel shelves are included. The shelves are perforated to improve airflow within the chamber.

Technical Data:

| | |
|---------------------------|--|
| Temp. Range | Ambient -10° to 55 °C |
| Temp. Accuracy: | ± 0.25°C (at 37°C) |
| Temp. Increments: | 0.1°C |
| Temp. Uniformity: | ± 0.25°C (at 37°C) |
| Capacity: | 20L or 0.8 cu. ft. |
| CO ₂ Range: | 0 to 20% |
| CO ₂ Sensor: | Dual beam IR |
| CO ₂ Accuracy: | ±0.1% at 5% |
| Humidity: | 70 to 80% |
| Gas Input: | 4mm |
| Dimensions: (W x D x H) | |
| Interior: | 10.3 x 9.3 x 12.9 in. / 26 x 23.5 x 33 cm |
| Exterior: | 13.2 x 14.5 x 18.7 in. / 33.5 x 37 x 48 cm |
| Weight: | 15 lbs (6.8kg) |
| Electrical: | Universal Voltage 100 to 240V, 50-60Hz, 75W |
| Warranty: | 2 Years |



Optional gas regulator



Easy access CO₂ input port

Ordering Information:

| Item No. | Description: |
|------------|--|
| H2300-HC2* | myTemp CO ₂ Mini Digital Incubator, includes 2 stainless shelves |
| H2300-REG | Optional CO ₂ gas regulator (regulates pressure from the gas cylinder to the incubator) |
| H2300-SH | Extra shelf, 10.5 x 8 in. stainless steel (autoclavable) |

*Includes US plug. For EU plug, please add (-E).

SureTherm™ Series CO₂ Incubators



- + Precision temperature control, six-sided heating
- + Available with IncuView LCI - Live Cell Imaging with wifi enabled, shelf mounted microscope
- + Excellent accuracy and recovery with dual beam IR sensor for measuring CO₂
- + Available with split inner door and digital control over oxygen percentage

Technical Data:

| | |
|----------------------------|---|
| Temp. Range: | Ambient +5°C to 60°C |
| Temp. Accuracy: | ± 0.1°C* |
| Temp. Uniformity: | ± 0.4. °C* |
| Temp. Stability: | ± 0.1°C* |
| Temp. Increments: | 0.1°C |
| CO ₂ Range: | 0 to 20% |
| CO ₂ Increment: | 0.1°C |
| CO ₂ Accuracy: | ± 0.1°C |
| CO ₂ Sensor: | Dual Beam IR CO Sensor |
| Heat Decontamination | 125°C (H3565-180HD series models only) |
| O ₂ Range: | 0.5 to 20% (H3565-180HDO2 model only) |
| Interior Dimensions: | (WxDxH) |
| H3565-45 | 13.2 x 14.2 x 15.4 in. / 33.5 x 36.1 x 39.2 cm |
| H3565-180 | 18.7 x 20.8 x 28 in. / 47.3 x 52.8 x 71 cm |
| H3565-180HD | 18.7 x 20.8 x 28 in. / 47.3 x 52.8 x 71 cm |
| H3565-180HDO2 | 18.7 x 20.8 x 28 in. / 47.3 x 52.8 x 71 cm |
| Chamber Volume: | 45L & 180L |
| Split Inner Door: | 6 compartments (H3565-180HDO2 only) |
| Chamber Material: | Stainless Steel 304 |
| Exterior Dimensions: | (WxDxH) |
| H3565-45 (45L) | 16.5 x 18.3 x 21.8 in. / 42 x 46.5 x 55.3 cm |
| H3565-180 (180L) | 22 x 26.2 x 37.2 in. / 56 x 66.5 x 94.5 cm |
| H3565-180HD (180L) | 22 x 26.2 x 37.2 in. / 56 x 66.5 x 94.5 cm |
| H3565-180HDO2 (180L) | 22 x 26.2 x 37.2 in. / 56 x 66.5 x 94.5 cm |
| Weight: | 45L: 77 lbs / 35kg, 180L: 172 lbs / 78kg |
| Electrical: | 120V or 230V, 50-60Hz (350W to 760W) |
| Warranty: | 2 years |

* At a set temperature of 37.0°C



Ordering Information:

| Item No. | Description: |
|----------------|---|
| H3565-45* | SureTherm CO ₂ Incubator, 45L, with 2 shelves |
| H3565-180* | SureTherm CO ₂ Incubator, 180L, with 3 shelves |
| H3565-180HD* | SureTherm CO ₂ Incubator, 180L, with High Heat Decontamination, 3 shelves |
| H3565-180HDO2* | Suretherm CO ₂ Incubator, 180L, with 3 shelves Includes: High heat decontamination, O ₂ control and split inner door with 6 compartments |
| H3565-45-LCI | IncuView LCI Integrated Shelf (14x11.5 in.) with integrated wifi microscope (for 45 Liter incubator) |
| H3565-180-LCI | IncuView LCI Integrated Shelf (20x17 in.) with integrated wifi microscope (for 180 Liter incubator) |
| H3550-45-SH | Additional shelf for 45L incubator, 1 each |
| H3550-180-SH | Additional shelf for 180L incubator, 1 each |
| H3550-45-SK | Stacking kit for 45L incubator |
| H3550-180-SK | Stacking kit for 180L incubator (height of top display approximately 135cm) |
| H2300-REG | CO ₂ regulator (optional), for CO ₂ control |
| H3565-O2REG | Nitrogen regulator (optional), for O ₂ control |

* 115V with US plug. For 230V (EU plug), please add (-E).

myBlock™ Series Digital Dry Baths



Benchmark's myBlock™ series are the first digital dry baths to include advanced microprocessor controls, timed operation and a removable, hinged lid. In addition, an optional external temperature feedback probe can be positioned directly inside a sample tube, providing real-time control and monitoring of **actual** sample temperature.

Both the single and dual block models can be ordered in a configuration that includes our unique Quick-Flip™ blocks. These universal blocks accept tubes from 0.5 to 2.0ml and with just a quick flip to the other side, accommodate 0.2ml tubes, PCR strips or (in the dual block model only) a PCR plate. In addition, a wide variety of blocks are available for tubes up to 50ml.

Ordering Information:

| Item No. | Description: |
|-------------|---|
| BSH5001-1B* | myBlock I single chamber with 1 x BSWCMB |
| BSH5002-2B* | myBlock II dual chamber with 2 x BSWCMB |
| BSH5001* | myBlock I single chamber, without blocks |
| BSH5002* | myBlock II dual chamber, without blocks |
| BSH-TP1 | Optional external temperature sensor |
| BSWCMB | Block, Quick-Flip, 24 x 1.5/2.0ml, 14 x 0.5ml, 6 x PCR strips / 48 x 0.2ml (& in dual model only) one PCR plate |
| BSW1500 | Block, 24 x 1.5ml |
| BSW1520 | Block, 24 x 1.5/2.0ml |
| BSW05 | Block, 24 x 0.5ml |
| BSW5MT | Block, 12 x 5.0ml snap cap centrifuge tubes |
| BSW15 | Block, 12 x 15ml** |
| BSW50 | Block, 5 x 50ml*** |
| BSW10 | Block, 20 x 10mm (or 20 x 2.0ml) |
| BSW13 | Block, 20 x 13mm (Blood Collection Tubes)** |
| BSWBCT | Block, 12 x 13mm & 8 x 16mm (Blood Collection Combi-Block)** |
| BSW1516 | Block, 12 x 15-16mm (or 12 x 10ml) |
| BSW02 | Block, 48 x 0.2ml tubes or 6 PCR tube strips |
| BSWPCR2 | Block, 1 x 96-well PCR Plate (2 block model only) |
| BSWPCR1 | Block, 1 x 96-well PCR Plate (1 block model) |
| BSWMT | Block, 1 x Micro Plate (2 block model only) |
| BSWHEM | Block, 48 x Hematocrit tubes (1.9mm) |
| BSW01 | Block, solid - for slides or custom machining |

*115V with US plug. For 230V (EU plug), please add (-E).

**Tube height may prevent the transparent lid from closing.

myBLOCK™

- + Hinged cover improves uniformity and conserves energy
- + Optional external temperature probe for control of actual sample temperature
- + Unique Quick-Flip™ universal micro-block

Available with: **Quick-Flip™** universal micro-block Patent Pending

All purpose blocks for:

- ✓ 0.5ml tubes
- ✓ 1.5ml tubes
- ✓ 2.0ml tubes
- ✓ 0.2ml tubes
- ✓ 0.2ml strips
- ✓ PCR Plate

Item: BSH5002-2B

Three possible block configurations in dual model:

| Side 1 & Side 1 | Side 1 & Side 2 | Side 2 & Side 2 |
|------------------------------|--|---------------------------------|
| | | |
| 48 x 1.5/2.0ml 28 x 0.5ml | 24 x 1.5/2.0ml 14 x 0.5ml 48 x 0.2ml | 96 x 0.2ml or One PCR Plate* |

*Single block chamber in myBlock I prevents compatibility with PCR plates.



Video Demonstration

Technical Data:

| | |
|-------------------------|--|
| Temp. Range: | Ambient +5° to 105°C |
| Temp. Accuracy: | ± 0.25°C |
| Temp. Increments: | 0.1°C |
| Temp. Uniformity: | ± 0.2°C |
| Timer: | 1 min. to 99 hr.: 59 min. |
| Dimensions (W x D x H): | |
| Single: | 7 x 10 x 5 in. / 18 x 25.5 x 13 cm |
| Dual: | 6.3 x 14.5 x 5 in. / 16 x 36.5 x 13 cm |
| Electrical: | 115V or 230V, 50-60 Hz, 120W (single) / 240W (dual) |
| Warranty: | 2 Years |

isoBlock™ Digital Dry Bath



CE

ISO BLOCK™
Two independent block chambers

- + Two isolated chambers
- + Independent time & temperature control
- + Hinged cover improves uniformity and conserves energy
- + Unique Quick-Flip™ Universal Micro-Block



Video Demonstration

The unique IsoBlock™ contains two isolated block chambers. Each chamber is controlled independently, allowing the dry bath to serve as two dry baths in one. The hinged (and removable) lid is designed with a dividing wall. When the lid is closed this dividing wall acts as a barrier, preventing air transfer between chambers.

The control panel features large digital displays of both time and temperature. At any point, either setting of a block can be adjusted, without affecting the settings of the other block.

A wide variety of blocks are available for accommodating nearly all popular tubes sizes. In addition, the unique Quick-Flip™ universal blocks accept tubes from 0.5 to 2.0ml and, with just a quick flip to the other side, accommodates 0.2ml tubes or PCR strips.



IsoBlock shown with lid open

Ordering Information:

| Item No. | Description: |
|----------|---|
| BSH6000* | IsoBlock Dry Bath with two independent chambers |
| BSWCMB | Block, Quick-Flip, 24 x 1.5/2.0ml, 14 x 0.5ml and 6 x PCR strips / 48 x 0.2ml |
| BSW1500 | Block, 24 x 1.5ml |
| BSW1520 | Block, 24 x 1.5/2.0ml |
| BSW05 | Block, 24 x 0.5ml |
| BSW5MT | Block, 12 x 5.0ml centrifuge tubes |
| BSW15 | Block, 12 x 15ml ** |
| BSW50 | Block, 5 x 50ml** |
| BSW10 | Block, 20 x 10mm (or 20 x 2.0ml) |
| BSW13 | Block, 20 x 13mm (Blood Collection Tubes)** |
| BSWBCT | Block, 12 x 13mm & 8 x 16mm (Blood Collection Combi-Block)** |
| BSW1516 | Block, 12 x 15-16mm (or 12 x 10ml) |
| BSW02 | Block, 48 x 0.2ml tubes or 6 PCR tube strips |
| BSWPCR1 | Block, 1 x 96-well PCR Plate |
| BSWHEM | Block, 48 x Hematocrit tubes (1.9mm) |
| BSW01 | Block, solid - for slides or custom machining |

Technical Data:

| | |
|-------------------------|---|
| Temp. Range: | Ambient +5° to 105°C |
| Temp. Accuracy: | +/- 0.25°C |
| Temp. Increments: | 0.1°C |
| Temp. Uniformity: | +/- 0.2°C |
| Timer: | 1min. to 99 hr & 59 min. |
| Dimensions (W x D x H): | 6.3 x 14.5 x 5 in. 16 x 37 x 12.7 cm |
| Electrical: | 115V or 230V, 50-60 Hz, 240W |
| Warranty: | 2 Years |

* 115V with US plug. For 230V (EU plug), please add (-E).

**Tube height may prevent lid from closing, temperature accuracy may be affected.

myBlock™ Heating / Cooling Mini Dry Baths



CE

With its compact construction, broad temperature range, and multiple block options, the myBlock Mini is the perfect tool for laboratory incubations. The simple touch pad controls and a digital display provide for "set and walk away" temperature selection and unrivaled accuracy.

While perfect for bench use, the optional 12V adapter expands the utility of the myBlock Mini to field use. At less than 4.3 inches wide, myBlock Mini is truly the first personal heat block.

Technical Data:

| Model: | BSH200 | BSH300 |
|--------------------------------|--|--|
| Temp. Range: | Amb. +5° to 100°C | Amb. -25° to 100°C |
| Min. Programmable Temperature: | 20°C | 0°C |
| Temp. Accuracy: | ± 0.5°C | ± 0.5°C |
| Temp. Increments: | 0.1°C | 0.1°C |
| Temp. Uniformity: | +/- 0.2°C | +/- 0.2°C |
| Dimensions: (W x D x H) | 4 x 6 x 4.5 in. 10.2 x 15 x 11.5 cm | 4.3 x 6.4 x 5.5 in. 11 x 16.2 x 14 cm |
| Weight: | 2 lbs (1kg) | 2 lbs (1kg) |
| Electrical: | 100-240V 50-60 Hz, 50W | 100-240V 50-60 Hz, 50W |
| Warranty: | 2 Years | 2 Years |

- + Compact, fits on any crowded benchtop
- + Available in heat only, or heat & cool versions
- + Exchangeable blocks for 0.2 to 50ml tubes
- + Clear cover improves temperature uniformity
- + Link 2 consecutive temperature steps (cooling model only)

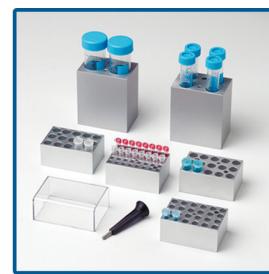

Ordering Information:

| Item No. | Description: |
|-------------|--|
| BSH200* | myBlock Mini Digital Dry Bath |
| BSH300* | myBlock Mini Digital Dry Bath with cooling |
| BSH100-02 | Block, 40 x 0.2ml or 5 PCR strips |
| BSH100-05 | Block, 24 x 0.5ml |
| BSH100-15 | Block, 15 x 1.5ml |
| BSH100-1520 | Block, 15 x 1.5 or 2.0ml |
| BSH100-5MT | Block, 6 x 5ml conical (17mm diameter)** |
| BSH100-150 | Block, 4 x 15ml** |
| BSH100-500 | Block, 2 x 50ml** |
| BSH100-1232 | Block, 15 x 2ml autosampler vials (12 x 32mm) |
| BSH100-1213 | Block, 15 x 12-13mm diameter tubes & vacutainers** |
| BSH100-CV | Block, 8 x cuvettes |
| BSH100-CU | Block, solid (for custom machining) |
| BSH100-A12 | 12V vehicle power adapter |

*Includes US plug. For EU plug, please add (-E)
**Block height may prevent lid from closing.



myBLOCK HL
With Heated Lid

Prevents evaporation and condensation

CE

For technical data, please see above (myBlock Mini).

Temp Accuracy: ± 0.3°C

Ordering Information:

| Item No. | Description: |
|-------------|--|
| BSH200-HL* | myBlock HL Mini Digital Dry Bath with heated lid |
| BSH100-02 | Block, 40 x 0.2ml or 5 PCR strips |
| BSH100-05 | Block, 24 x 0.5ml |
| BSH100-15HL | Block, 15 x 1.5ml |

*Includes US plug. For EU plug, please add (-E).

The new myBlock™ HL is the first and only mini heat block featuring a heated lid for protecting samples against unwanted condensation and evaporation. Both the block and lid temperature can be selected independently, making this myBlock the ideal choice for the most temperature sensitive applications, including LAMP assays, immunoassays, enzyme reactions - anywhere reactant concentration is critical.

myBath™ Digital Water Baths

myBATH™ SERIES
The complete family of water baths



CE

- + Digital accuracy and convenience
- + Seamless, stainless steel chamber
- + Quik-CAL™ user calibration function
- + Hinged lid is also removable

The myBath series water baths are designed to guarantee superior accuracy and performance in a compact footprint. Easy to use controls allow the user to digitally select and monitor settings. Adjustable in 0.1 degree increments, the temperature is shown on a large, 3-digit display. The proprietary Quik-CAL™ feature allows for simple, in-lab calibration. High efficiency insulation maintains temperature stability and uniformity within the bath, while keeping the housing cool to the touch.

All myBath models feature seamless, stainless steel chambers for easy cleaning and long life. The chambers resist rust and have no corners to collect dirt or contamination. The larger 8L and 12L units have drains for hassle-free water changes.

The 4L, 8L, and 12L models include a see-through cover that can be removed, or flipped back on a rear hinge to conserve bench space. The lid's gabled design** will divert condensation to the front and back of the bath, away from samples. Racks are available to accommodate 1.5/2.0ml, 15ml and 50 ml tubes within the 4L, 8L and 12L baths. The myBath 4L is supplied with all three racks.

**The 2L model includes a flat, removable lid and adjustable temperature in increments of 1°C.

Ordering Information:

| Item No. | Description: |
|-----------|--|
| B2000-2* | myBath 2L Digital Water Bath |
| B2000-4* | myBath 4L Digital Water Bath, includes tube racks for 1.5/2.0, 15 and 50ml tubes |
| B2000-8* | myBath 8L Digital Water Bath |
| B2000-12* | myBath 12 L Digital Water Bath |

*115V with US plug. For 230V (EU plug), please add (-E).

Accessory Tube Racks:

Tube racks *included* with myBath 4L!



| Item Number | Description: | Rack Capacity | |
|---------------|------------------------------------|---------------|------------|
| | | 4 Liter | 8/12 Liter |
| B2000-4-T5 | Tube rack for 40 x 0.5ml tubes | 1 | 2 |
| B2000-4-T1520 | Tube rack for 48 x 1.5/2.0ml tubes | 1 (Included) | 2 |
| B2000-4-T150 | Tube rack for 41 x 15ml tubes | 1 (Included) | 0 |
| B2000-4-T500 | Tube rack for 15 x 50ml tubes | 1 (Included) | 0 |
| B2000-8-T150 | Tube rack for 76 x 15ml tubes | 0 | 1 |
| B2000-8-T500 | Tube rack for 30 x 50ml tubes | 0 | 1 |

Technical Data:

| | 2 Liter | 4 Liter | 8 Liter | 12 Liter |
|-----------------------|---------------------------------|---------------------|------------------------|------------------------|
| Temperature Range: | Ambient +5° to 100°C | | | |
| Temp. Accuracy: | ± 0.2°C at 37°C | | ± 0.5°C at 37°C | |
| Temp. Uniformity: | ± 0.2°C at 37°C | | | |
| Exterior (W x D x H): | 6.5 x 8 x 6 in. | 7.7 x 13.9 x 9 in. | 11.2 x 17.5 x 12.4 in. | 11.2 x 17.5 x 16.2 in. |
| Interior (W x D x H): | 5.5 x 6 x 4 in. | 5.3 x 9.4 x 5.5 in. | 9.5 x 12.8 x 5.9 in. | 9.5 x 12.8 x 7.9 in. |
| Weight: | 4.5 lbs (2.4 kg) | 15 lbs (6.8 kg) | 17 lbs (7.7 kg) | 17 lbs (7.7 kg) |
| Electrical: | 115 or 230V, 50-60Hz, 250W-700W | | | |
| Warranty: | 2 Years | | | |

BeadBath Duo™ Digital Bead Baths

BEAD BATH DUO™

THE ONLY BATHS DESIGNED FOR BEADS OR LIQUIDS



CE

- + Two separate modes for **BEADS** or **WATER**
- + Quik-Cal™, simple in-lab calibration function
- + Offers all of the advantages of a “Bead Bath”
 - Eliminates constant refills (burn-out protection)
 - Easy, accessory free securing of tubes and bottles
 - Allows angled incubations
 - Designed to be left on constantly (no wait for heat-up)



Choose Bead or Water Mode

The BeadBath Duo series is the first line of laboratory baths designed for precision temperature control when used with water, or with the increasingly popular Lab Armor® thermal beads.

Unlike any other laboratory bath, they feature a “MODE” button that can be used to toggle between “Bead” or “Water” mode. Choosing the correct mode will regulate the internal heating system, automatically adjusting the operation and balance of the multiple internal heating elements to ensure optimal performance. The result is one combination bath that is suitable for accurate and uniform temperature control in either condition.

While the majority of research laboratories today are using water baths, many prefer the convenience of bead baths. The BeadBath Duo provides the best of both worlds, allowing conversion from one bath type to the other, with the simple press of a button.

Lab Armor is a registered trademark of Lab Armor, LLC.

Technical Data:

| | |
|-------------------|---|
| Temp. Range: | Water Mode: Ambient +5 to 80°C Bead Mode: Ambient +5 to 70°C |
| Capacity: | 2L / 10L |
| Temp. Accuracy: | ± 0.2°C |
| Temp. Increments: | 1°C |
| Temp. Uniformity: | Water Mode: ±0.2°C Bead Mode: ±0.9°C |
| 2L Model | (W x D x H) |
| Exterior Dims.: | 6.5 x 8 x 6 in. / 16.5 x 20.3 x 15.2 cm |
| Chamber Dims.: | 5.5 x 6 x 4 in. / 13.9 x 15.2 x 10.1 cm |
| Weight: | 5 lbs. / 2.2 kg |
| Electrical: | 115 or 230V, 50-60Hz, 150W |
| 10L Model | (W x D x H) |
| Exterior Dims.: | 10.8 x 16 x 12 in. / 27.4 x 40.6 x 30.5 cm |
| Chamber Dims.: | 9.5 x 11.8 x 6.1 in. / 24.1 x 30 x 15.5 cm |
| Weight: | 15 lbs. / 6.8kg |
| Electrical: | 115 or 230V, 50-60Hz, 550W |
| Warranty: | 2 Years |

Ordering Information:

| Item No. | Description: |
|----------|------------------------------------|
| B2402* | BeadBath Duo™ 2L with lift-off lid |
| B2410* | BeadBath Duo™ 10L with hinged lid |

*Includes US plug. For EU plug, please add (-E)



SB-12L Shaking Water Bath

SB-12L Shaking Water Bath



CE

This compact shaking water bath utilizes the well proven, beltless motor drive system from the Benchmark Orbi-Shaker™ Series, with the addition of precision temperature control up to 80°C. The seamless, stainless steel chamber has a 12 liter capacity. The unit is supplied complete with a universal spring platform for securing 15 & 50ml test tubes, as well as Erlenmeyer flasks and media bottles up to 1 liter. A hinged and removable lid is also included to reduce energy waste, prevent splashing and divert condensation away from samples.

- + Orbital shaking motion
- + Included spring platform accepts tubes, bottles and flasks
- + Compact design, conserves bench space
- + Digital control and display of time, temperature, and speed

Capacity Chart:

| | Bottles/Tubes | Flasks |
|-----------|---------------|--------|
| 0.5ml | 40 | N/A |
| 1.5/2.0ml | 40 | N/A |
| 15ml | 63 | N/A |
| 50ml | 15/30 | 12 |
| 125ml | 8 | 8 |
| 250ml | 4 | 3 |
| 500ml* | 2 | 2 |
| 1000ml* | 2 | 1 |

*Height of vessel may limit ability to close included lid.

Technical Data:

| | |
|----------------------------------|---|
| Temperature Range: | Ambient +5° to 80°C |
| Temperature Increments: | 0.1°C |
| Temperature Uniformity | ± 0.2°C (at 37°C) |
| Temperature Accuracy: | ±0.3°C (at 37°C) |
| Shaking Speed Range: | 30 to 200rpm |
| Speed Increments: | 1rpm |
| Shaking Orbit: | 25mm (1") |
| Platform Dimensions: | 6.5 x 8 in. / 16.5 x 20.5cm |
| Exterior Dimensions: (W x D x H) | 12.2 x 13.25 x 12 in. / 32 x 34 x 30 cm |
| Capacity: | 12 Liter |
| Timer: | 1 min. to 48 hours / continuous |
| Weight: | 31 lbs. (14kg) |
| Electrical: | 115 or 230V, 50-60Hz, 300W |
| Warranty: | 2 Years |

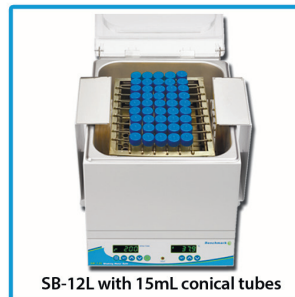

SB-12L with 15mL conical tubes



SB-12L with 50mL conical tubes

Ordering Information:

| Item No. | Description: |
|--------------|--|
| SB0012* | SB-12L Shaking Water Bath with universal spring platform for tubes, bottles and flasks |
| SB0012-T1520 | Optional rack for 1.5/2.0ml microtubes |
| SB0012-T5 | Optional rack for 0.5ml microtubes |

*115V with US plug. For 230V (EU plug), please add (-E).

- + Heated lid prevents condensation
- + Accepts a variety of microplates
- + Available in two-plate or four-plate format
- + Temperature control up to 70°C

INCUB-MIXER™ MP
HEATED MICROPLATE VORTEXER

Ordering Information:

| Item No. | Description: |
|--------------|---|
| H6002* | Incu-Mixer MP2, 2 position incubated plate vortexer |
| H6004* | Incu-Mixer MP4, 4 position incubated plate vortexer |
| BT1500-A1520 | Optional adapter, 20 x 1.5/2.0ml for microplate shakers |
| BT1500-A05 | Optional adapter, 20 x 0.5ml for microplate shakers |

*115V with US plug. For 230V (EU plug), please add (-E).



CE

**Vortex mixing motion,
up to 1200rpm**

Incu-Shaker™ Mini Shaking Incubator



CE

INCUSHAKER™ Mini

- + Domed lid accepts flasks up to 1L
- + Touch screen control panel
- + Extremely compact: just 11" wide
- + Exchange flask clamps in one second with MAGic Clamp™ magnetic system

The Incu-Shaker™ Mini is the most compact shaking incubator in its class. While this shaking incubator has a remarkably small footprint, the interior is spacious enough to accept a 9.5 x 11" platform as well as clamps for a variety of flasks, tubes and other common vessels. The standard platform (included) features a non-slip, rubber coated surface, ideal for tissue culture flasks, Petri dishes and staining trays.

The convenient MAGic Clamp™ platform is also available for use with Erlenmeyer flasks and test tube racks. This unique, magnetic attachment method is the easiest way to instantly change between flask clamps of different sizes.



The INSTANT flask attachment system



H1000-MR-1550

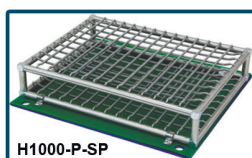

H1000-P-SP



Video Demonstration



Technical Data:

| | |
|----------------------------------|--------------------------------------|
| Temperature Range: | Ambient +5° to 70°C |
| Temperature Increments: | 0.1°C |
| Temperature Uniformity: | ± 0.25 °C |
| Temperature Accuracy: | ±0.1 °C |
| Shaking Speed Range: | 30 to 300rpm |
| Speed Increments: | 1rpm |
| Shaking Orbit: | 19mm (3/4") |
| Platform Dimensions: | 9.5 x 11.5 in. / 23.5 x 29 cm |
| Exterior Dimensions (W x D x H): | 11 x 16.2 x 13 in. / 28 x 41 x 33 cm |
| Height with Lid Open: | 25 in. / 63 cm |
| Timer: | 1 min. to 48 hours / continuous |
| Weight: | 25 lbs. (11.5kg) |
| Electrical: | 115 or 230V, 50-60Hz, 250W |
| Warranty: | 2 Years |

Ordering Information:

| Item No. | Description: |
|--|---|
| H1001-M* | Incu-Shaker Mini with non-slip rubber mat |
| H1000-MR | MAGic Clamp universal platform (for flasks/tubes) |
| H1000-P-MP | 4 x microplate platform (standard or deepwell) |
| H1000-P-SP | Spring rack platform, for uncommon vessels |
| Accessories for H1000-MR MAGic Clamp Platform | |
| H1000-MR-CMB | NEW! Adjustable flask clamp for MAGic clamp platform, accepts 125ml (max. 12), 250ml (max. 8) or 500ml (max. 5) |
| H1000-MR-1000 | Flask clamp for MAGic clamp platform, 1000ml (max. 2) |
| H1000-MR-500 | Flask clamp for MAGic clamp platform, 500ml (max. 5) |
| H1000-MR-250 | Flask clamp for MAGic Clamp platform, 250ml (max. 8) |
| H1000-MR-125 | Flask clamp for MAGic Clamp platform, 125ml (max. 12) |
| H1000-MR-50 | Flask clamp for MAGic Clamp platform, 50ml (max. 20) |
| H1000-MR-MP | MAGic clamp for 1 x microplate (max. 4) |
| H1000-MR-1550 | Tube Rack, 30x15 & 20x50ml (max. 1) |
| H1000-MR-T15 | Tube Rack, 32 x 15ml (max. 2) |
| H1000-MR-T50 | Tube Rack, 15 x 50ml (max. 2) |
| H1000-MR-TSR | Angled tube rack holder, adjustable tilt (max. 1) |

*115V with US plug. For 230V (EU plug), please add (-E).



Incu-Shaker™ 10L Shaking Incubators

INCUSHAKER™ 10L

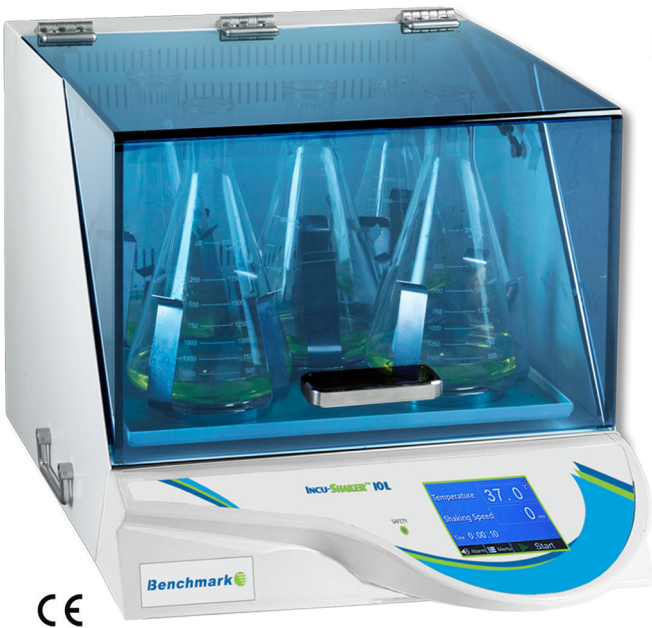

- + Two models, heat only & heat/cool
- + Exceptional temperature uniformity
- + High capacity, up to 5 x 2L
- + Exchange flask clamps in one second with MAGIC Clamp™ magnetic system
- + Optional shelf for Petri dishes, microplates, etc.



Video Demonstration



The *INSTANT* flask attachment system

Incu-Shaker™ 10L is a heavy-duty performer, designed for high capacity loads and continuous use. Its outstanding temperature accuracy and uniformity are supported by proprietary heat distribution technology that ensures precisely maintained temperatures throughout the chamber. Inconsistencies due to stratification are reduced to negligible levels and the selected temperature is precisely maintained within 0.25%, even in the corners. In the Incu-Shaker 10LR model, a powerful compressor provides cooling as low as 15 degrees below ambient.

The powerful brushless induction drive is designed for years of trouble-free service, even under continuous use conditions with heavy loads. Noise and vibration are minimized by an advanced motor isolation system. Like other Incu-Shaker models, the 10L is built to last. A standard, rubber mat platform is included and is ideal for use with tissue culture flasks, Petri dishes, staining trays and other flat vessels. The convenient MAGIC Clamp™ platform is also available for use with Erlenmeyer flasks and test tube racks. The unique, magnetic attachment method is the easiest way to instantly change between flask clamps of different sizes.

Technical Data:

| | |
|---------------------------|---|
| Temperature Range: | |
| H2010: | Ambient +5° to 60°C |
| H2012: | Ambient -15° to 60°C |
| Temperature Increments: | 0.1°C |
| Temperature Uniformity: | ± 0.1.25% |
| Temperature Accuracy: | ±0.1°C |
| Shaking Speed Range: | 30 to 300rpm |
| Speed Increments: | 1 rpm |
| Shaking Orbit: | 19mm (3/4") |
| Platform Dimensions: | 17.8 x 17.8 in. / 45 x 45 cm |
| Chamber Height/Clearance: | 12 in. / 30.5m |
| Exterior Dimensions: | |
| H2010 (W x D x H): | 20 x 26 x 19 in. / 51 x 65 x 47 cm |
| H2012 (W x D x H): | 20 x 31 x 22 in. / 51 x 79 x 56 cm |
| Height (lid open): | 38 in. / 96.5 cm |
| Timer | 1 min. to 48 hours or continuous |
| Weight (H2010): | 120 lbs (55kg) |
| Weight (H1012): | 170 lbs (78kg) |
| Electrical (H2010): | 120 or 230V, 50-60Hz, 450W |
| Electrical (H1012): | 120 or 230V, 50-60Hz, 950W |
| Warranty: | 2 Years |

Ordering Information:

| Item No. | Description: |
|--|--|
| H2010* | Incu-Shaker 10L with non-slip rubber mat |
| H2012* | Incu-Shaker 10LR (refrigerated) w/ non-slip rubber mat |
| H1010-MR | MAGic Clamp Universal platform (for flasks/tubes) |
| H1010-P-SP | Spring rack platform, for uncommon vessels |
| H1010-SH | Shelf, 14 x 5.5" for Petri dishes, microplates, etc. |
| Accessories for H1010-MR MAGIC Clamp Platform | |
| H1000-MR-CMB | NEW! Adjustable flask clamp for MAGic clamp platform, accepts 125ml (max. 36), 250ml (max. 25) or 500ml (max. 16) |
| H1000-MR-3000 | Flask clamp for MAGic clamp platform, 3L (max. 4) |
| H1000-MR-2000 | Flask clamp for MAGic clamp platform, 2L (max. 5) |
| H1000-MR-1000 | Flask clamp for MAGic clamp platform, 1L (max. 9) |
| H1000-MR-500 | Flask clamp for MAGic clamp platform, 500ml (max. 16) |
| H1000-MR-250 | Flask clamp for MAGic Clamp platform, 250ml (max. 25) |
| H1000-MR-125 | Flask clamp for MAGic Clamp platform, 125ml (max. 36) |
| H1000-MR-50 | Flask clamp for MAGic clamp platform, 50ml (max. 49) |
| H1000-MR-MP | Clamp, 1 x microplate, for MAGic Clamp platform (max.. 8) |
| H1000-MR-1550 | Tube Rack, 30x15 & 20x50ml (max. 4) |
| H1000-MR-T15 | Tube Rack, 32 x 15ml (max. 8) |
| H1000-MR-T50 | Tube Rack, 15 x 50ml (max. 8) |
| H1000-MR-T600 | Tube/Bottle Rack, 4 x 500/600ml conical bottle (max. 4) |
| H1000-MR-TSR | Angled tube rack holder, adjustable tilt (max. 1) |

*115V with US plug. For 230V (EU plug), please add (-E).

Incu-Shaker™ Mini CO₂ Shaking Incubator



CE

INCUSHAKER CO₂ Mini

Heat • Shake • CO₂

The ONLY CO₂ Incubator with a MAGIC Clamp™ Shaker

- + Integral orbital shaker, ideal for suspension cell culture
- + Six side direct heating, provides uniform temperature
- + Stainless steel chamber (SS316), with round corners for easy cleaning
- + Dual beam IR sensor, fast response time for precise control over CO₂%

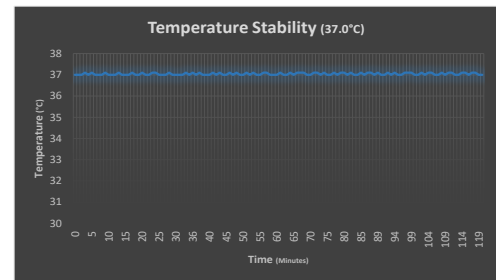

Temperature Stability Chart: Chamber temperature for a 2 hour duration following stabilization (within 0.1°C) at 37.0°C.



MAGic Clamp™ Platform

Optional MAGic Clamp accessories (Patented) are available for attaching erlenmeyer flasks, microplates, test tube racks and other vessels to the shaking platform. This patented design allows for instant, magnetic attachment of clamps without the use of tools, screws and other hardware.

Sealed Inner Glass Door

The inner glass door is transparent, allowing visualization of samples without fully exposing the chamber to the ambient environment, improving performance and reducing energy waste.



Heated Door

The six sided, direct heating design provides the highest level of temperature uniformity (±0.5). In addition, the heated door prevents the forming of condensation on the inner glass door, for improved sample visualization.

Adjustable, pull out shelf

An included stainless steel shelf allows shaking of suspended cells while simultaneously incubating adherent cells. This static shelf can be pulled outward for easy loading/unloading and can be adjusted (or removed) for shaking taller vessels.



Technical Data:

| | |
|--|---|
| Temperature Range: | Ambient +5° to 60°C (Increments: 0.1°C) |
| Temperature Accuracy / Uniformity / Stability: | ±0.5°C / ±0.5°C / 0.1°C (at 37°C) |
| Speed Range: | 30 to 300 rpm (Increments: 1rpm) |
| Mixing Orbit: | 19mm (3/4 in.) |
| CO ₂ Range: | 0 to 20% (Increment: 0.1%) |
| CO ₂ Accuracy: | ±0.1% |
| Time Range: | 1 min. to 48 hours (or continuous) |
| Platform Dimensions: | 9.5 x 11.5 in. (23.5 x 29 cm) |
| Chamber Dimensions: | 13.2 x 10.25 x 15.4 in. / 33.5 x 26 x 39.2 cm (46L) |
| Exterior Dimensions: | 16.5 x 18.3 x 21.8 in. / 42 x 46.5 x 55.3 cm |
| Weight: | 90 lbs (40.kg) |
| Electrical: | 120V or 230V, 50-60Hz, 350W |
| Warranty: | 2 Years |

Ordering Information:

| Item No. | Description: |
|---------------|--|
| H3501* | Incu-Shaker CO₂ Mini, with non-slip rubber mat platform |
| H2300-REG | Optional CO ₂ Gas Regulator MAGic Clamp Accessories |
| H1000-MR | MAGic Clamp Universal Platform, 9.5 x 11.5 inch |
| H1000-MR-CMB | MAGic Clamp Adjustable Flask Clamp, for 125, 250 & 500ml Erlenmeyer flasks (max. 12 x 125ml, 8 x 250ml or 5 x 500ml) |
| H1000-MR-50 | MAGic Clamp Flask Clamp, for 50ml Erlenmeyer flask (max. 20) |
| H1000-MR-125 | MAGic Clamp Flask Clamp, for 125ml Erlenmeyer flask (max. 12) |
| H1000-MR-250 | MAGic Clamp Flask Clamp, for 250ml Erlenmeyer flask (max. 8) |
| H1000-MR-500 | MAGic Clamp Flask Clamp, for 500ml Erlenmeyer flask (max. 5) |
| H1000-MR-1000 | MAGic Clamp Flask Clamp, for 1L Erlenmeyer flask (max. 4) |
| H1000-MR-MP | MAGic Clamp Flask Clamp, for microplates (max. 4) |
| H1000-MR-T15 | MAGic Clamp Tube Rack, 32 x 15ml (max. 2) |
| H1000-MR-T50 | MAGic Clamp Tube Rack, 15 x 50ml (max. 2) |
| H1000-MR-1550 | MAGic Clamp Tube Rack, 32 x 15ml (max. 1) |
| H1000-MR-T600 | MAGic Clamp Tube Rack, 4 x 500/600ml bottles |
| H1000-MR-TSR | Slanted Rack Holder, holds tube racks at an adjustable angle |

*115V with US plug. For 230V (EU plug), please add (-E).

Maximum Capacity:

| 50ml Flasks | 125ml Flasks | 250ml Flasks | 500ml Flasks | 1000ml Flasks | Micro-plates | 15ml Tubes | 50ml Tubes |
|-------------|--------------|--------------|--------------|---------------|--------------|------------|------------|
| 20 | 12 | 8 | 5 | 4 | 4 | 64 | 30 |



Roto-Therm™ Incubated Rotator

Roto-THERM™



- + Rotated mixing with temperature control
- + Includes tube holders for common tube sizes
- + Available with variable speed control and advanced shaking/mixing modes:
 - + Mix (oscillating)
 - + Pause
 - + Rock

Roto-THERM™ PLUS



Benchmark's new Roto-Therm series of rotating mixers provide a wide range of mixing capabilities. Suitable for an array of laboratory applications including resuspension, protein binding, nucleic acid purification, histochemistry, hybridization, etc, the mixers include interchangeable tube holders for accommodating all common tube sizes from 0.5ml to 50ml. The motion can be adjusted from vertical (end over end) mixing, to horizontal (rolling or hybridization style) mixing.

For applications requiring temperature control, the Roto-Therm series can be digitally programmed to maintain chamber temperatures of ambient +5°C to 60°C and include an "in-lab" calibration function for ensuring accurate temperature control. For applications where temperature control is not required, the economical Roto-Mini models are available (pg. 30).

Roto-Therm rotators are available in the "Plus" configuration. The Plus models provide the following additional features:

- Variable speed: 5 to 70rpm
- "Mix" function: Rotating in combination w/ oscillations (increased mixing)
- "Pause" function: Rotating with intermittent "stops" during rotation
- "Rock" function: Back and forth, gentle rocking motion (see-saw)

The Plus models also offer an additional rocking platform (4.5 x 3 in.), as well as a 96 x 0.2ml tube/strip/plate holder for mixing PCR vessels in the "Mix" (oscillating) mode

Included Tube Holders:

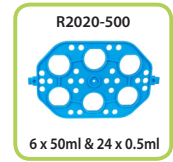
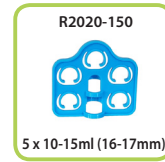
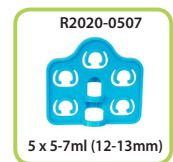

Optional Tube Holders:

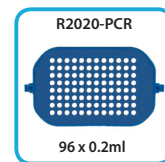

Technical Data:

| | |
|----------------------|---|
| Speed Range: H2020: | 24rpm |
| H2024: | 5 to 70rpm |
| Mixing Modes: H2020: | N/A |
| H2024: | Mix, Pause & Rock |
| Temperature: | Ambient +5° to 60°C |
| Max Capacity: | 1.5ml/2.0ml: 44 15ml:16 50ml: 6 |
| Dimensions: | 11.6 x 8.5 x 9 in / 29.5 x 21.6 x 22.9 cm |
| Weight: | 9 lbs / 4kg (H2020) / 10 lbs / 4.5kg (H2024) |
| Electrical: | 115 or 230V, 50-60Hz, 0.5A |
| Warranty: | 2 Years |

Ordering Information:

| Item No. | Description: |
|--------------------------------|--|
| H2020* | Roto-Therm Incubated Rotator with tube holders |
| H2024* | Roto-Therm Plus Incubated Rotator (variable speed) with tube holders |
| Tube Holder Accessories | |
| R2020-1520 | Tube holder, 11 x 1.5/2.0ml, 2/pk (1 pack included) |
| R2020-0507 | Tube holder, 5 x 5-7ml, 2/pk (1 pack included) |
| R2020-150 | Tube holder, 4 x 10-15ml, 2/pk (1 pack included) |
| R2020-500 | Tube holder, 6 x 50ml, 1 each (included) |
| R2020-PCR | Tube holder, 96 x 0.2ml, 12 x PCR strips or one PCR plate** |
| R2020-RP | Mini rocking platform with rubber mat, 4.5 x 3 in. ** |

*115V with US plug. For 230V (EU plug), please add (-E).

**Accessories are recommended for "Plus" models (H2024) only

MultiTherm™ Heating/Cooling Vortexer



MULTI-THERM™
COOL - HEAT - SHAKE

- + Temperature control from 0° to 100°C
- + Exchangeable blocks, for tube sizes 0.2ml to 50ml
- + Precision contoured wells for uniform thermal transfer
- + Two models: Heat/Cool or Heat only
- + Sequence link function for linking or repeating programs (HC model only)



The MultiTherm™ shaker is a temperature controlled vortexer, useful for a variety of molecular biology applications, including:

- Denaturation of DNA, RNA & proteins
- Lipid extractions
- Yeast and bacteria cultivation
- Restriction digests
- Reverse transcription
- DNA/plasmid isolation
- Gentle thawing of biological materials

Technical Data:

| | |
|-------------------------|---|
| Temp. Range (HC): | Ambient -20° to 100°C |
| Temp. Range (H): | Ambient +5° to 100°C |
| Heating Ramp Rate: | 5.0°C / min. |
| Cooling Ramp Rate: | 2.5°C / min. (HC only) |
| Temp. Accuracy: | ± 0.5°C |
| Speed Range: | 200 to 1500 rpm, or "off" |
| Timer: | 1 min. to 99 hrs. 99 min. / continuous |
| Motion / Orbit: | Orbital / 3mm |
| Capacity: | Per selected block |
| Dimensions: (W x D x H) | 8.25 x 11.5 x 8.25 in. 21 x 29 x 21 cm |
| Weight: | 18 lbs (8kg) |
| Electrical: | 115V or 230V, 50-60Hz, 500W |
| Warranty: | 2 Years |

Despite its modest footprint, the MultiTherm accommodates all common laboratory tubes and plates, including as many as 6x50ml tubes. Speed, temperature and time are set digitally and current as well as set values are continuously shown on the LCD. A heat only model, as well as a heat and cool model are available. The HC model includes a sequence link function for linking together temperature profiles. An integral over-temperature control ensures long life, safety and sample integrity. Blocks are sold separately.

Ordering Information:

| Item No. | Description: |
|------------|---|
| H5000-HC* | MultiTherm Shaker with heating and cooling |
| H5000-H* | MultiTherm Shaker with heating only |
| H5000-02 | Block, 96 x 0.2ml or 1 PCR plate |
| H5000-05 | Block, 54 x 0.5ml |
| H5000-CMB | Block, combination, 15x0.5ml & 20x1.5ml |
| H5000-15 | Block, 35 x 1.5ml |
| H5000-20 | Block, 35 x 2.0ml |
| H5000-12 | Block 24 x 12mm (200-1200rpm / Amb.-10° to 100°C) |
| H5000-150 | Block, 15 x 15ml (200-750rpm / Amb.-10° to 100°C) |
| H5000-500 | Block, 6 x 50ml (200-750rpm / Amb.-10° to 100°C) |
| H5000-MP | Block, 1 x microplate (Amb. -10 to 60°C) |
| H5000-1232 | Block, 24 x 2ml HPLC / Autosampler vials (12x32mm) |
| H5000-5MT | Block, 12 x 5ml centrifuge tubes (conical) |
| H5000-DWMP | Block, 1 x deep well microplate (max. height, 54mm) |
| H5000-CU | Block, custom drilled, for tubes/vials up to 40mm tall |
| H5000-WB | Block, for liquids, beads, etc. (chamber: 4 x 2.6 x 1") |

*115V with US plug. For 230V (EU plug), please add (-E).

MULTI-THERM™ Touch
COOL - HEAT - SHAKE



- + Large, full color touch screen
- + Tool-less block exchange
- + Optional heated lid

Ordering Information:

| Item No. | Description: |
|------------|---|
| H5100-HCT* | MultiTherm Touch with heating and cooling |
| H5100-HL | Optional heated lid, adjustable height |

*Includes US plug. For EU plug, please add (-E).

*Wide range of accessory blocks available, visit www.benchmarkscientific.com



Benchmark TC-32 and TC-9639 Thermal Cyclers



- + Intuitive touchscreen control
- + Program wizard for quick & easy protocol entry
- + Fast, reliable results
- + Fully adjustable heated lid
- + Full sized model with gradient option
- + Mini version for low throughput labs

Fast, reliable cycling and ease of use make the Benchmark thermal cyclers the ideal choice for medium to high throughput laboratories as well as teaching facilities or those looking for a personal sized cyclers.

Both the full-sized TC-9639 and mini TC-32 feature large, full color touchscreens with icon driven menus. A program wizard guides users through quick and easy entry of protocols with on board storage for over 100 typical programs. The TC-9639 has been upgraded with a gradient option for quick optimization or protocols.

The unique format of the block in the TC-9639 accepts 0.2ml tubes, strips and PCR plates as well as 0.5ml tubes. Wells in the block of the TC-32 are arranged in a 4x8 format compatible with 0.2ml tubes or strips. The blocks have a low thermal mass, allowing for exceptionally fast heating and cooling. This process is tightly controlled to maintain precision, accuracy, and uniformity both in the block and the samples. Heated lids maintain reactant concentrations. The height of the heated platen in the lid of the TC-9639 can be adjusted to fit snugly against the tops of tubes and plates.

While the TC-32 has a smaller footprint and lower capacity than the TC-9639, it still maintains many of the same programming features including time and temperature increments/decrements, auto pause, auto restart after a power failure and the ability of maintain samples at 4°C after a run.



Touchscreen control

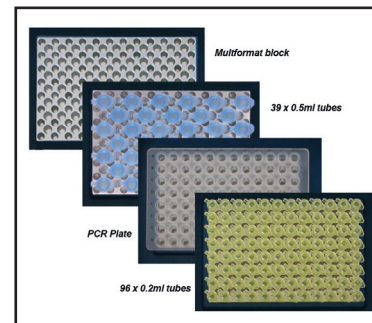

Unique block format (TC-9639)

Technical Data:

| | |
|-------------------------------------|---|
| Capacity, TC-32 Mini: | 32 x 0.2ml or 4 PCR Strips |
| Capacity, TC-9639 Multifomat Block: | 96 x 0.2ml tubes/strip tubes or 39 x 0.5ml tubes or 1 nonskirted 96 well plate |
| 384 Well Block: | 1 x 384 well plate (TC-9639 only) |
| In-situ Adapter: | 4 slides (fits multiformat block) |
| Temp. Control Range: | 0° to 100°C |
| Temperature Control: | Simulated sample or block |
| Accuracy/Uniformity: | ±0.2°C/±0.2°C (TC-9639) ±0.25°C/±0.25°C (TC-32) |
| Max. Ramp Rate: (Heat/Cool): | 5°C per sec. / 4°C per sec. |
| Lid Temperature: | 30° to 112°C, user adjustable |
| Gradient Range/Differential: | 30°-105°C left to right/ 1°-30°C (TC-9639) |
| Program Memory: | Up to 100 programs (TC-9639 offers unlimited storage with a USB flash drive) |
| Increments/decrements: | Yes, time and temperature |
| Power Failure Restart: | Yes |
| Dimensions (TC-9639): | 10.2 x 14.2 x 9.9 in. / 26 x 36 x 25cm |
| Dimensions (TC-32): | 9.1 x 7.1 x 6.2 in / 23 x 18 x 15.7 cm |
| Weight: | 16 lbs (7.3kg) / 7 lbs (3.2kg) |
| Electrical: | Universal Voltage 100 to 240V, 50-60 Hz |
| Warranty: | 2 Years |

Ordering Information:

| Item No. | Description: |
|-------------|---|
| T5005-3205* | TC-32 Mini Thermal Cycler, 32 x 0.2ml block |
| T5000-96* | TC-9639 Thermal Cycler, multiformat block (Accepts 1 PCR plate, 96 x 0.2ml tubes or 39 x 0.5ml tubes) |
| T5000-384* | TC-9639 Thermal Cycler, 384 well block |
| T5000-A-IS | In-situ adapter for 4 slides, fits T5000-96 |

*Includes US plug. For EU plug, please add (-E).

Also Available from Benchmark



Pg. 68



CoolCube™
Microtube/PCR Plate Cooler

Pg. 69



Hybex™ Media Storage Bottles

Pg. 70



Benchmark™ Agarose Powder

Pg. 70



Benchmark™ Agarose Tablets

CoolCube™ Microtube and PCR Plate Cooler

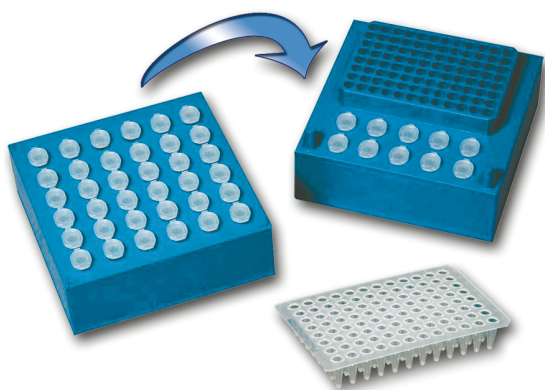

CoolCube™

- + Maintains 0°C for 4 hours
- + Ideal for:
 - 1.5ml & 2.0ml microtubes
 - 0.2ml PCR tubes & strips
 - 96 well PCR plates
- + Also for use as a PCR workstation

The CoolCube™ is designed to keep samples cold on the lab bench without the mess of a melting ice bucket. Simply place the CoolCube in a freezer overnight and it's ready for use, keeping samples cold, but not frozen. Maintains temperature at approximately 0° C for up to four hours.

Ordering Information:

| Item No. | Description: |
|----------|---|
| R1000 | CoolCube Microtube and PCR Plate Cooler |

Technical Data:

| | |
|-------------------------|---|
| Temperature: | 0°C for up to 4 hours |
| Capacity: | |
| Top Side: | 36 x 1.5/2.0ml tubes |
| Bottom Side: | 96 x 0.2ml tubes 12 x 0.2ml strips 1 x 96 well PCR plate 10x 1.5/2.0ml |
| Dimensions: (W x D x H) | 5.6x5.6x2.5 in. 14.3 x 14.3x 6.4 cm |
| Weight: | 2 lbs (1kg) |
| Warranty: | 2 Years |

hybex™ Media Storage Bottles

hybex™



B3000-Series

- + Borosilicate 3.3 hybex™ glass
- + Autoclavable caps (GL45) & drip rings
- + Permanent enamel graduation markings
- + Large area for bottle marking/identification
- + Autoclavable, reuseable & breakage resistant

Ordering Information:

| Item No. | Description: |
|---------------|---|
| B3000-50-B | Bottle, 50ml with GL32 blue cap, 10/pk. |
| B3000-100-B* | Bottle, 100ml with standard (GL45) blue cap, 10/pk. |
| B3000-250-B* | Bottle, 250ml with standard (GL45) blue cap, 10/pk. |
| B3000-500-B* | Bottle, 500ml with standard (GL45) blue cap, 10/pk. |
| B3000-1000-B* | Bottle, 1L with standard (GL45) blue cap, 10/pk. |
| B3000-2000-B* | Bottle, 2L with standard (GL45) blue cap, 10/pk. |
| B3000-SP-B* | Bottle, Starter Pack with standard (GL45) blue cap, includes, 2x100ml, 3x250ml, 3x500ml and 2x1 L |
| B3000-CAP-B* | Replacement cap, standard blue (GL45), 10/pk. |
| B3000-CAP2 | Replacement cap, standard blue (GL32), 10/pk. |
| B3000-CAP-HTC | High temperature caps, red (GL45), up to 180°, 10/pk. |

*Please replace (-B) with (-G) for green caps, (-P) for purple caps, (-Y) for yellow caps, (-W) for white caps or (-AS) for assorted caps (2 of each color).

Technical Data:

| | |
|--------------------|---|
| Material: | hybex borosilicate glass (3.3) |
| Cap Thread Size: | GL45 |
| Temperature Range: | -70° to 500°C |
| Sterilization: | Autoclave |
| Cap Material: | Polypropylene (140°C) |
| Cap Colors: | Standard blue, green, purple, yellow, white or assorted |

hybex™ Erlenmeyer Flasks

Technical Data:

| | |
|-------------------------------|--------------------------------|
| Material: | hybex borosilicate glass (3.3) |
| Cap Thread Size: (B3220 only) | GL45 |
| Temperature Range: | -70° to 500°C |
| Sterilization: | Autoclave |
| Cap Material: (B3220 only) | Blue Polypropylene (140°C) |

Ordering Information:

| Item No. | Description: |
|--------------------------|--|
| Erlenmeyer Flasks | Borosilicate 3.3 glass (standard, no caps or threads) |
| B3110-50 | 50ml Erlenmeyer flask, 12/pk |
| B3110-125 | 125ml Erlenmeyer flask, 12/pk |
| B3110-250 | 250ml Erlenmeyer flask, 12/pk |
| B3110-500 | 500ml Erlenmeyer flask, 6/pk |
| B3110-1000 | 1000ml Erlenmeyer flask, 6/pk |
| B3110-2000 | 2000ml Erlenmeyer flask, 6/pk |
| Erlenmeyer Flasks | Borosilicate 3.3 glass (standard, with caps) |
| B3220-250 | 250ml Erlenmeyer flask with GL45 cap, 12/pk |
| B3220-500 | 500ml Erlenmeyer flask with GL45 cap, 6/pk |
| B3220-1000 | 1000ml Erlenmeyer flask with GL45 cap, 6/pk |
| B3220-2000 | 2000ml Erlenmeyer flask with GL45 cap, 1/pk |
| B3000-CAP-B* | Replacement cap, standard blue (GL45), 10/pk. |
| B3000-CAP-HTC | High temperature caps, red (GL45), up to 180°, 10/pk. |



B3220-Series



B3110-Series

Benchmark™ Agarose



- + Multi-purpose, high purity
- + Green Choice, free from organic solvents
- + Enhanced resolution and clarity
- + Low EEO / increased electrophoretic mobility
- + RNase, DNase and Protease free

Ordering Information:

| Item No. | Description: |
|----------|----------------------------|
| A1700 | Benchmark Agarose LE, 25g |
| A1701 | Benchmark Agarose LE, 100g |
| A1705 | Benchmark Agarose LE, 500g |

Technical Data:

| | |
|------------------------|------------------------------|
| Gel Strength: | ≥ 1200g/cm ² (1%) |
| Gel Temperature: | 36°C ±1.5°C (1.5%) |
| Melt Temperature: | 88°C ±1.5°C (1.5%) |
| EEO (-mr): | 0.13 |
| Moisture Content: | ≤ 7% |
| Sulfate: | ≤ 0.2% |
| RNase / DNase: | None detected |
| Protease/Endonuclease: | None detected |
| Storage Conditions: | Room temperature |

Also Available: Benchmark Specialty Agarose:

| | |
|-----------|--|
| A1801-LM* | Benchmark Agarose Low Melting Point, 100g |
| A1801-HR* | Benchmark Agarose Hi-Res (PCR grade), 100g |
| A1801-31* | Benchmark Agarose 3:1, 100g |

Agarose LE: General purpose agarose, suitable for a range of applications and separations of DNA fragments from 150bp to 25kb.

Agarose LM: Ideal for DNA recovery after electrophoresis and for separations of fragments from 200bp to 25kb.

Agarose HR: Best choice for resolving small fragments from 20bp to 800bp.

Agarose 3:1: This blend of LE and Hi-Res agarose is designed of resolving fragments less than 1000bp.

* For technical data, or any additional information, please visit www.BenchmarkScientific.com

EZ Pack™ Agarose Tablets (0.5g)



- + Eliminates weighing
- + Fast dissolving, just 2 minutes
- + Convenient blister pack protects tablet integrity
- + Consistent reproducible gels
- + Low EEO, standard molecular biology grade
- + Produced without the use of organic solvents

Technical Data:

| | |
|------------------------|------------------------------|
| Gel Strength: | ≥ 1200g/cm ² (1%) |
| Gel Temperature: | 36°C ±1.5°C (1.5%) |
| Melt Temperature: | 88°C ±1.5°C (1.5%) |
| EEO (-mr): | 0.13 |
| Moisture Content: | ≤ 7% |
| Sulfate: | ≤ 0.2% |
| RNase / DNase: | None detected |
| Protease/Endonuclease: | None detected |
| Storage Conditions: | Room temperature |

Ordering Information:

| Item No. | Description: |
|----------|--|
| A2501 | EZ Pack Agarose Tablets, 100g (200 tablets) |
| A2505 | EZ Pack Agarose Tablets, 500g (1000 tablets) |

Accuris™ Instruments



Pg. 72

Laboratory Weighing



Pg. 76

Liquid Handling



Pg. 77

Automated Cell Counter



Pg. 78

Absorbance and Purification Instruments



Pg. 82

Electrophoresis



Pg. 85

Gel Visualization



Pg. 88

Power Supply

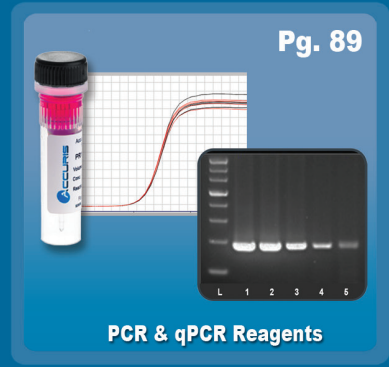

Pg. 89

PCR & qPCR Reagents

Accuris™ Mini Balances



CE

- + Super compact, less than 3" wide
- + Easy to read, backlit LCD
- + Calibration function
- + Includes two AAA batteries
- + Snap on, protective cover



Optional in-lab calibration weights



Protective cover, included

Accuris Mini Balances are extraordinarily compact, easy to use, and convenient for a variety of laboratory weighing applications. With a footprint of only 2.6 x 3.9 inches, they offer exceptional accuracy and linearity through their full range.

Available with a 100g or 500g capacity, these balances feature an easy to read, backlit, digital liquid crystal display and an in-lab calibration function (weights

Ordering Information:

| Item No. | Description: |
|-----------|--|
| W4000-100 | Accuris™ Mini Balance, 100g capacity (0.01g readability) |
| W4000-500 | Accuris™ Mini Balance, 500g capacity (0.1g readability) |

| Model | Mini 100g | Mini 500g |
|-----------------|--|-----------|
| Max Capacity : | 100 grams | 500 grams |
| Readability: | 0.01 g | 0.1 g |
| Calibration: | External | |
| Pan Size: | 2.1 x 2.25 in / 5.3 x 5.7 cm | |
| Weighing Units: | g, ct, dwt, gn | |
| Display: | backlit LCD | |
| Power: | 2 AAA batteries | |
| Exterior Dims.: | 2.6 x 3.9 x 0.75 in / 6.6 x 9.9 x 1.9 cm | |

sold separately). ON/OFF, MODE & TARE buttons are easily accessed.

Powered by 2 AAA batteries (included), power shuts off after 1 minute of sitting idle to conserve battery life. Ideal for lab or field use, each balance includes a snap on, protective cover with convenient, printed instructions.

Accuris™ Classic Analytical Balances

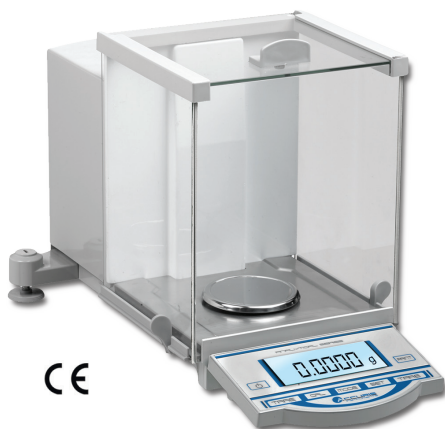

CE

- + Readable to 0.0001g (0.1 mg)
- + Available with Quick-Cal™ internal calibration option
- + Multiple program options (standard weighing, count mode & percent)

Accuris Analytical Balances provide accuracy and precision for the most demanding research applications. Two capacity options are available, each incorporating a highly precise, electromagnetic force restoration sensor to deliver unsurpassed accuracy & readability to 0.0001g (0.1mg). Although all models incorporate in-lab calibration firmware, they are also available with a unique Quick-Cal™ function (Items: W3100A-120 & W3100A-210) that provides fast, reliable internal calibration with the push of a button.



Shield opens from the left, right, and top for easy access



Extended base, limits vibration & improves stability

| Item No.* | W3100-120 | W3100-210 | W3100A-120 | W3100A-210 |
|----------------------------|---|-----------|---|------------|
| Calibration | External (100g cal. weight included) | | Internal Quick-Cal™ | |
| Capacity | 120 grams | 210 grams | 120 grams | 210 grams |
| Readability | 0.0001 grams | | 0.0001 grams | |
| Repeatability/Linearity | 0.0001 / 0.0002 | | 0.0001 / 0.0002 | |
| Pan Size | Stainless Steel: 3.5 in. Ø (9cm) | | Stainless Steel: 3.5 in. Ø (9cm) | |
| Weighing Units | g, oz, lb, ct, pieces, % | | g, oz, lb, ct, pieces, % | |
| Draft Shield | Yes, glass | | Yes, glass | |
| Exterior Dims. (W x D x H) | 32 x 47 x 28 cm 12.5 x 18.5 x 11 in. | | 32 x 47 x 28 cm 12.5 x 18.5 x 11 in. | |

*Includes US plug. For EU plug, please add (-E).



- + Readable to 0.01mg (W3002A-120)
- + Quick-Cal™ internal calibration
- + RS232 port for printer connection
- + Available with full color touch screen (series TX)

The Series Dx and Tx analytical balances are the most advanced in the Accuris line with a precision engineered Electromagnetic Force Restoration (EFR) weigh cell to accurately determine masses to sub milligram levels. Both series include internal calibration, ensuring that the balance is always calibrated and ready for use. Auto calibration can also be set to occur at specific time intervals depending on user preference. The Tx Series features a large, high resolution touch screen presenting the user with an icon-based menu system and allowing quick and intuitive access to a wide range of useful functions.

CE

| | Dx Series | Dx Series | Tx Series | Tx Series |
|-------------------------------|---|------------|-----------------------------------|--------------|
| Item No.* | W3101A-120 | W3101A-220 | W3002A-120 | W3102A-220 |
| Capacity | 120 grams | 220 grams | 120 grams | 220 grams |
| Readability | 0.0001g (0.1mg) | | 62g x 0.01mg 120g x 0.1mg | 220g x 0.1mg |
| Linearity | ± 0.2mg | | ± 0.08mg ± 0.2mg | ± 0.2mg |
| Repeatability | ± 0.1mg | | ± 0.03mg ± 0.1mg | ± 0.1mg |
| Calibration | Internal Quick Cal™ and External | | | |
| Pan Size (round) | 80mm | | | |
| Weighing Units | g, mg, carats, oz, lbs, dwt, t oz, gn | | | |
| Display Type | 5.25 x 1.5 in. backlit LCD | | 4.25 x 2.5 in. color touch screen | |
| Exterior Dims. (W x D x H) | 34.29 x 21.59 x 33.02 cm 13.5 x 8.5 x 13 in. | | | |

*Includes US plug. For EU plug, please add (-E).



High resolution touch screen



RS232 & USB port* for Printer, PC & flash drive connections
*USB on TX models only

AccuCheck™ Pipette Calibration System



Accuris Tx Semi-Micro Balance with built-in Pipette Check software



Anti Evaporation Trap (included)



Thermal Printer (optional)



The new AccuCheck System from Accuris Instruments gives your lab the freedom to calibrate pipettes quickly and when required. The system combines our popular Tx touch screen analytical balance with an anti evaporation trap accessory and built-in pipette calibration software. Together, this standalone pipette calibration system is easy for any lab tech to use for the ISO 8655 method of pipette calibration.

The user interface of the AccuCheck™ software is intuitive and requires no special training to use. Individual pipette details (brand, model, serial number) can be saved in the internal data base for current and future calibrations. The software walks the user through all steps of the gravimetric method, allows input of water temp, air temp, pressure, and humidity. It saves the weight values, and then performs all calculations for accuracy and precision at 3 volume settings. The Anti Evaporation Trap greatly improves results when performing the gravimetric method by preventing unstable measurements due to evaporation loss.

Ordering Information:

| Item No. | Description: |
|---------------|--|
| W3002A-120ACS | AccuCheck Pipette Calibration System (W3002-120A Balance with integrated pipette calibration software and Anti Evaporation Trap) |
| W3130 | Serial Printer for Accuris Balances |

Removing the Anti Evaporation Trap allows the Tx Semi-Micro balance to be used for general weighing applications. Offering a maximum capacity of 120g, readability of 62g x 0.01mg / 120g x 0.1mg, and automatic internal calibration, the Tx balance is a favorite for labs needing fast and accurate weight determinations.



Compact



Precision

Variable capacitance technology offers reliability, precision and fast stabilization

- + Large, user-friendly interface
- + Easy, in-lab calibration
- + RS232 port for data output and printing
- + Multiple program options (standard weighing, count mode, percent, etc.)



Accuris **Compact** and **Precision** balances quickly and accurately display sample mass measurements on a large, backlit LCD control panel. Utilizing a highly precise, gold plated ceramic capacitance sensor, these balances can provide reliable measurements to 0.001 grams (Precision models). All models feature multiple program options for standard weighing, count (or pieces) mode, as well as percent calculation. In addition, each balance incorporates firmware for easy and reliable, in-lab calibration.

The economical **Compact** balances are ideal for a wide range of **general weighing** applications. They are available with a readability of 0.01g or 0.1g. Six models cover a range of up to 10,000 grams. With enhanced shock resistance and overload protection, the **Compact** series is ideal for general purpose weighing at medium precision, in varying environments.

The **Precision** series balances are designed for more critical laboratory applications. Engineered for true **research grade** weighing capabilities, these balances offer higher levels of precision and readability (0.01g and 0.001g). They are useful for any laboratory application that does not require a dedicated analytical balance with sub-milligram readability. Advanced software ensures error-free weighing for various applications, including count weighing, percent calculation and inspection mode.

Compact Balances

| Item No.* | W3300-120 | W3300-300 | W3300-500 | W3300-1200 | W3300-5K | W3300-10K |
|-----------------------------|----------------------|------------|----------------|--------------------|--------------|--------------|
| Capacity: | 120 grams | 300 grams | 500 grams | 1200 grams | 5000 grams | 10000 grams |
| Readability: | 0.01 grams | 0.01 grams | 0.01 grams | 0.1 grams | 0.1 grams | 0.1 grams |
| Pan Size (round): | 11.5cm / 4.5 in. | | 16cm / 6.3 in. | | 18cm / 7 in. | 18cm / 7 in. |
| Repeatability/Linearity: | 0.01 / 0.02 | | | 0.1 / 0.2 | | |
| Draft Shield: | Yes, plastic ring | | | No | | |
| Weighing Units: | g, oz, ct, pieces, % | | | | | |
| Calibration: | External | | | | | |
| Exterior Dims.: (W x D x H) | 18.8 x 28 x 8 cm | | | 7.5 x 11 x 3.1 in. | | |

Precision Balances

| Item No.* | W3200-120 | W3200-320 | W3200-500 | W3200-1200 | W3200-3200 | W3200-5K |
|-----------------------------|---|-------------|-------------|--|------------|------------|
| Capacity: | 120 grams | 320 grams | 500 grams | 1200 grams | 3200 grams | 5000 grams |
| Readability: | 0.001 grams | 0.001 grams | 0.001 grams | 0.01 grams | 0.01 grams | 0.01 grams |
| Pan Size (round): | 11.5cm / 4.5 in. | | | 16cm / 6.3 in. | | |
| Repeatability/Linearity: | 0.001 / 0.002 | | | 0.01 / 0.02 | | |
| Draft Shield: | Yes, 3-door glass enclosure | | | No | | |
| Weighing Units: | g, oz, ct, pieces, % | | | | | |
| Calibration: | External | | | | | |
| Exterior Dims.: (W x D x H) | 20.5 x 35 x 31cm 8 x 13.75 x 12.25 in. | | | 20.5 x 35 x 8cm 8 x 13.75 x 3.1 in. | | |

*Includes US plug. For EU plug, please add (-E).



- + Various individual and weight sets available
- + Choose E2, F1, or M1 OIML class
- + Includes Certificate of Verification

Accuris calibration weights are ideal for routine calibration of your Accuris (or any brand) lab balance. Single weights as well as complete weight sets are available in various tolerance classes: OIML class E2, F1, and M1.



W1100-200

F1 Class: Suitable for precision 0.01 to 0.001g readability balances



W1106-100

E2 Class: Recommended for analytical 0.0001g readability balances



W1105-13-1000

M1 Class: Ideal for basic (compact) 0.1 to 0.01g readability balances

Ordering Information:

| Item No. | Description: |
|---------------|--|
| W1000-100 | Accuris™ Calibration Weight (F1 grade) 100g |
| W1000-200 | Accuris™ Calibration Weight (F1 grade) 200g |
| W1000-500 | Accuris™ Calibration Weight (F1 grade) 500g |
| W1000-1000 | Accuris™ Calibration Weight (F1 grade) 1kg |
| W1005-1 | Accuris™ Calibration Weight (M1 grade) 1g |
| W1005-2 | Accuris™ Calibration Weight (M1 grade) 2g |
| W1005-5 | Accuris™ Calibration Weight (M1 grade) 5g |
| W1005-10 | Accuris™ Calibration Weight (M1 grade) 10g |
| W1005-20 | Accuris™ Calibration Weight (M1 grade) 20g |
| W1005-50 | Accuris™ Calibration Weight (M1 grade) 50g |
| W1005-100 | Accuris™ Calibration Weight (M1 grade) 100g |
| W1005-200 | Accuris™ Calibration Weight (M1 grade) 200g |
| W1005-500 | Accuris™ Calibration Weight (M1 grade) 500g |
| W1005-1000 | Accuris™ Calibration Weight (M1 grade) 1kg |
| W1005-2000 | Accuris™ Calibration Weight (M1 grade) 2kg |
| W1000-TF | Tweezers, for handling calibration weights |
| W1100-200 | Calibration set for Precision Balances (Class F1) 23 pcs, 1mg to 200g, includes protective case, tweezers, dust brush and cleaning cloth |
| W1101-6-100 | Calibration set for Analytical Balances (Class E2) 6 pcs: 100mg, 10g, 2x20g, 50g, 100g, incl. protective case, tweezers & cleaning cloth |
| W1105-13-1000 | Economy calibration set for compact balances (Class M1), 13 pcs: 1x1g, 2x2g, 1x5g, 1x10g 2x20g, 1x50g, 1x100g, 2x200g, 1x500g, 1x1kg, includes protective case |



Individual weights come in a protective case. Weight sets include a protective carrying case with foam liner. All weights are supplied with a certificate of verification.

ASPIRE™ Laboratory Aspirator



CE

- + Compact design
- + Built-in vacuum pump
- + Adjustable vacuum control
- + Vacuum gauge
- + Overflow protection
- + Autoclavable

Quietly and safely aspirate liquids



Comes complete with:

Base with internal vacuum pump
2 Liter, polycarbonate collection bottle
Antibacterial / hydrophobic filter
Silicone tubing
Handheld vacuum controller (A)
Adapter for 200µl pipette tips (B)
Adapter, fine stainless steel, 40mm (C)

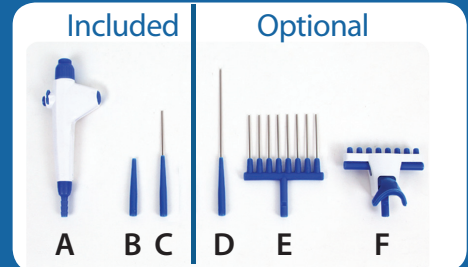

Ordering Information:

| Item No. | Description: |
|-----------|---|
| V0020* | ASPIRE™ Laboratory Aspirator, 115V Includes base with internal vacuum pump, 2L polycarbonate bottle with lid, silicone tubing, handheld vacuum controller and single channel adapters |
| V1002-1SL | Optional single channel adapter, X-long (80mm) stainless steel (D) |
| V1002-S8 | Optional eight channel adapter, fine tip stainless steel (E) |
| V1002-8 | Optional 8-channel adapter, for use with 200µl pipette tips (F) |
| V1002 | Handheld vacuum controller with single channel adapters (A, B, C / included), can be used with in house systems |
| V0020-F1 | Hydrophobic filter, 1/pk (one included with V0020) |
| V0020-QD | Optional quick disconnect kit for collection bottle, includes 2 male/female attachments & silicone tubing |
| V0020-BOT | Graduated, PC collection bottle with lid (included) |
| V0020-TB | Extra vacuum tubing with connector, 1 meter |

*115V with US plug. For 230V (EU plug), add (-E).

Technical Data:

| | |
|-------------------------|---|
| Max. Aspiration Rate: | 14ml / sec. |
| Max. Flow Rate: | 15L / min. |
| Vacuum Range: | -30mbar to -750mbar |
| Noise Level: | 59.6 db |
| Dimensions: (W x D x H) | 9.5 x 7.9 x 13.5 in. 24 x 20 x 34 cm |
| Weight: | 4.8lbs (2.2kg) |
| Electrical: | 115V, or 230V, 50Hz to 60Hz |
| Warranty: | 2 years |

NextPette™ Precision Pipettes

- + Market leading accuracy and precision
- + One-handed, thumb wheel volume adjustment
- + Volume lock
- + Ceramic pistons (on 20, 100, 200 and 1000µl models)

NEXTPETTE™



Ordering Information & Technical Data:

| Item No.* | Description: | Inaccuracy: | Imprecision: | Tip Size: |
|------------|--|---------------|---------------|-----------|
| P7700-1 | NextPette™ Variable Volume Pipette 0.1 to 1.0 µl | ± 20 to 2% | ± 12 to 1.2% | 10 µl |
| P7700-10 | NextPette™ Variable Volume Pipette 0.5 to 10 µl | ± 3.8 to 0.5% | ± 4 to 0.5% | 10 µl |
| P7700-20 | NextPette™ Variable Volume Pipette 2 to 20 µl | ± 3 to 0.8% | ± 3 to 0.8% | 200 µl |
| P7700-100 | NextPette™ Variable Volume Pipette 10 to 100 µl | ± 1.5 to 0.8% | ± 1.5 to 0.8% | 200 µl |
| P7700-200 | NextPette™ Variable Volume Pipette 20 to 200 µl | ± 1.2 to 0.6% | ± 1.0 to 0.6% | 200 µl |
| P7700-1000 | NextPette™ Variable Volume Pipette 100 to 1000 µl | ± 1.5 to 0.6% | ± 1.0 to 0.6% | 1000 µl |
| P7700-5M | NextPette™ Variable Volume Pipette 1ml to 5ml* | ± 0.6 to 0.5% | ± 0.6 to 0.5% | 5 ml* |
| P7700-10M | NextPette™ Variable Volume Pipette 1ml to 10ml** | ± 2.5 to 0.5% | ± 2.0 to 0.5% | 10 ml** |
| P7700-CAR | NextPette™ Carousel stand holds 6 NextPette Pipettes | | | |
| P7700-S1 | Micro NextPette™ Starter Set, includes 4 pipettes (P7700-10, P7700-20, P7700-200 and P7700-1000) and a carousel stand | | | |
| P7700-S2 | Macro NextPette™ Starter Set, includes 4 pipettes (P7700-200, P7700-1000, P7700-5M*, P7700-10M**) and a carousel stand | | | |
| P7700-T5M | 5ml Pipette Tips, fit 1ml to 5ml NextPette, (P7700-5M), 100 per pack | | | |
| P7700-T10M | 10ml Pipette Tips, fit 1ml to 10ml NextPette (P7700-10M), 100 per pack | | | |



Large, 4 digit volume display faces the user

*Requires pipette tip P7700-T5M **Requires pipette tip P7700-T10M



- + Compatible with most common mammalian cell lines
- + Fast, accurate and reproducible results
- + Intuitive software and touch-screen interface
- + Convenient and cost-effective QuadSlides™
- + Count sample volumes up to 3.6ul

With count speeds as fast as 20 seconds per sample, the Accuris QuadCount provides many advantages over the tedious and time consuming manual hemocytometry method. The advanced software eliminates human bias in dead/live determinations, reduces counting errors, saves time, and improves efficiency. Cells are also measured during each count.

The QuadCount utilizes a unique 4-chambered disposable QuadSlide™. Four samples can be processed in one slide (twice the capacity of standard 2-chambered slides), decreasing consumable costs. Each chamber has a hydrophilic inner surface with an engraved grid pattern. High precision production and molding ensure that each QuadSlide meets the rigorous standards and dimensional tolerances required for optimal counting performance.

3 count modes available to analyze different sample volumes:

- Quick Mode: 0.15uL / 20 seconds (1 image frame)
- Normal Mode: 0.9uL / 30 seconds (6 image frames)
- Precise Mode: 3.6uL / 100 seconds (24 image frames)

The QuadCount's ability to analyze larger sample volumes/multiple images, provides significantly better accuracy than other cell counters.



Four chambered QuadSlide™

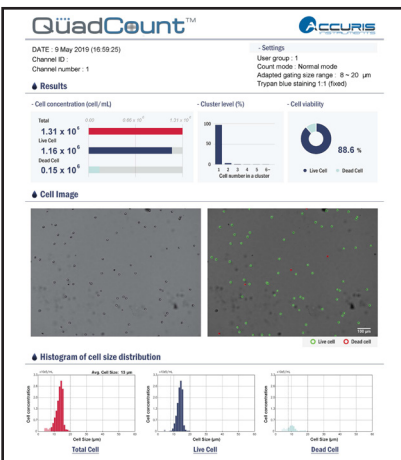

PDF reports can be exported

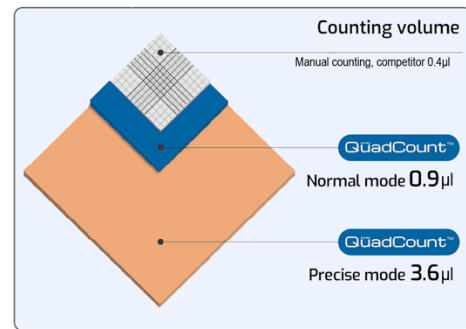

Technical Data:

| | |
|-------------------------|---|
| Optics: | High quality 4x objective lens |
| Pixel Resolution: | 2592 x 1944 |
| Image Detection: | 5 mega pixel CMOS sensor |
| Illumination: | Green LED (50,000 hour life) |
| Sample Volume: | 20ul (4 samples per QuadSlide) |
| Max. Counting Volume: | 3.6ul (24 image captures) |
| Consumable Slide: | QuadSlide, 4-chamber |
| Counting Modes/Speeds: | Quick (20 sec), Normal (30 sec), Precise (100 sec) |
| Dynamic Range: | 1 x 10 ⁶ to 1 x 10 ⁷ cells per ml |
| Data Output: | USB drive for PDF repor |
| Dimensions: (W x D x H) | 6.4 x 11.5 x 8.5 in. 16.3 x 29.3 x 21.6 cm |
| Weight: | 11 lbs (4.9kg) |
| Electrical: | 115V or 230V, 50Hz to 60Hz |
| Warranty: | 2 years |

Ordering Information:

| Item No.* | Description: |
|------------|--|
| E7500* | QuadCount™ Automated Cell Counter, 115V |
| E7500-S1 | QuadSlides, 50/pk. |
| E7500-ST51 | Standard test slide for QuadCount™, 1/pk |

*115V with US plug. For 230V (EU plug), add (-E).

SmartReader™ 96 Microplate Absorbance Reader



CE

New model, MR9600-T, now available with temperature control for plate incubation.

- + Intuitive, 7 inch color touch screen control panel
- + Filter based system, wavelength range from 340 to 750nm
- + Stand alone system, with USB flash drive for data transfer
- + Absorbance range: 0.0 to 4.000 Abs
- + Integrated, multispeed plate shaker

Technical Data:

| | |
|-------------------------|---|
| Control and Display: | 7" touch screen, 800 x 480 pixels |
| Light Source: | Quartz halogen lamp, 6V/10W |
| Wavelength Range: | 340-750nm (405, 450, 492 and 630nm filters included) |
| Read Speed: | <6 sec. for 96 well plate |
| Temp. Control: | +5 to 50°C / Accuracy ±0.5°C @ 37°C Uniformity ±0.5°C @ 37°C |
| Shaking: | 3 modes: slow (3.5Hz), medium (4.7Hz), fast (7.0Hz) |
| Dimensions: (W x D x H) | 11.6 x 17 x 8.75 in. 29.5 x 44 22.5 cm |
| Weight: | 22 lbs (10kg) |
| Electrical: | 115V or 230V, 50Hz to 60Hz |
| Warranty: | 2 years |

Ordering Information:

| Item No.* | Description: |
|-----------|--|
| MR9600* | SmartReader™ 96 Microplate Absorbance Reader for 96 well plates, 115V |
| MR9600-T* | SmartReader™ 96 Microplate Absorbance Reader, with Temp. Control, 115V |
| MR9600-PC | SmartReader PC Software for MR9600 and MR9600-T |
| MR9600-TP | Thermal Printer for SmartReader 96 |

*115V with US plug. For 230V (EU plug), add (-E).

SmartReader™ UV-Vis Microplate Reader



CE

- + Intuitive color touch screen control
- + Accepts both 96 and 384-well plates
- + Monochromator system, wavelength range 200-1000nm
- + Stand-alone system with USB flash drive for data transfer



SmartDrop™ plate for checking nucleic acid and protein concentration/purity using small sample droplets.

Technical Data:

| | |
|-------------------------|---|
| Plates Accepted: | 96-well and 384-well flat bottom, and SmartDrop™ plate |
| Control and Display: | 10" touch screen |
| Light Source: | Xenon Flash Lamp |
| Wavelength Range: | 200-1000nm with 1nm steps |
| Wavelength Selection: | Monochromator |
| Plate Shaking: | Linear; three options for speed |
| Incubator: | From ambient + 5°C to 45°C |
| Ports: | 3 USB ports, for PC, printer and flash drive |
| Dimensions: (W x D x H) | 12 x 19.5 x 11.5 in. 300 x 500 x 290 mm |
| Weight: | 33 lbs (15kg) |
| Electrical: | DC24V, 6.5A (100 to 240 VAC input) |
| Warranty: | 2 years |

Ordering Information:

| Item No.* | Description: |
|-----------|---|
| MR9610* | SmartReader™ UV-Vis Microplate Reader, for 96 and 384 Well Plates, 115V |

*115V with US plug. For 230V (EU plug), add (-E).



- + Quick set up and easy programming
- + Compatible with U, V, C, and flat bottom 96 well plates
- + Flexible programming for full plate, partial plate, or strip washing
- + Choose 8-channel or 12-channel wash head
- + Individually controlled wash and rinse sources

CE

Research requires flexibility – the SmartWasher™ 96 provides it. Full plates, partial plates, and strips with U, V, C, or flat bottoms are accepted by this fully automated washer. Multiple aspiration point settings allow for minimal residual liquid in the wells after aspiration. All parameters, including dispense volume, suction time, soak and shake cycles, and shaking speed are easily programmed using the large 4.3" LCD display and keypad. Up to 100 wash protocols can be stored on board the SmartWasher™ 96 and recalled when needed, or transferred between machines with a flash drive.

The washer comes equipped with 2 wash bottles, 1 rinse bottle and a waste bottle. All have sensors that alert the user when the solutions are low, or in the case of the waste bottle, when it needs to be emptied. An auto-rinse function primes the dispensing tube and wash heads to prevent cross contamination and clogs.

8- and 12-channel manifolds (purchased separately) accommodate plates in either orientation. A transparent, acrylic shield surrounds the wash area, allowing for visualization of the plate. Should a spill or leak occur, the beveled spill well ensures that the liquid is extracted immediately to avoid cross-contamination.

The SmartWasher™ 96 is the perfect partner for the SmartReader™ 96 Microplate Absorbance Reader as well as other popular readers.

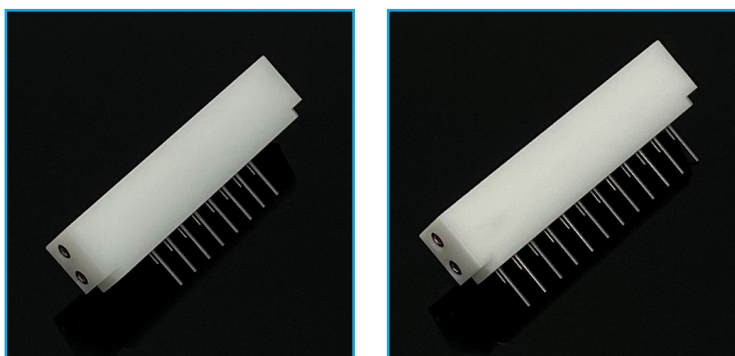

8- and 12-channel manifolds, purchased separately, are available to accommodate different plate orientations

Technical Data:

| | |
|----------------------------|---|
| Control and Display: | 7" touch screen, 800 x 480 pixels |
| Light Source: | Quartz halogen lamp, 6V/10W |
| Wavelength Range: | 340-750nm (405, 450, 492 and 630nm filters included) |
| Half-Bandwidth of filters: | 3~9nm |
| Read-out Range: | 0-4.000 Abs |
| Linearity (405nm) | 0-2.00 Abs <+1% 2-4.000 Abs <+2% |
| Resolution: | 0.001 Abs |
| Accuracy (405nm) | +1% (0-3 Abs) +2% (3-4 Abs) CV≤1.0% (3-4 Abs) |
| Precision (405nm) | CV≤0.2% (0-3 Abs) CV≤1.0% (3-4 Abs) |
| Test Speed: | <6 seconds for a 96 well plate |
| Temp. Control: | +5 to 50°C / Accuracy ±0.5°C @ 37°C Uniformity ±0.5°C @ 37°C |
| Shaking: | Slow, medium or fast mode |
| User Interface: | Menu driven software, touch screen |
| Storage: | 200 programs, 100,000 test records |
| Ports: | USB for printer, mouse, PC and flash drive |
| Dimensions: (W x D x H) | 11.6 x 17 x 8.75 in. 29.5 x 44 22.5 cm |
| Weight: | 22 lbs (10kg) |
| Electrical: | 115V or 230V, 50Hz to 60Hz |
| Warranty: | 2 years |

Ordering Information:

| Item No. | Description: |
|-------------|--|
| MW9600* | SmartWasher 96 for 96 Well Plates, 115V (Wash heads sold separately) |
| MW9600-8CM | 8 channel manifold |
| MW9600-12CM | 12 channel manifold |

*115V with US plug. For 230V (EU plug), add (-E).

SmartDrop™ Nano Spectrophotometer

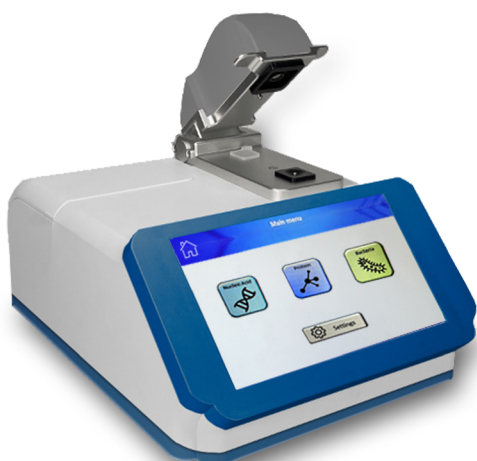

- + Three models to meet various application requirements
- + Quick, accurate, easy to use
- + Large color touch screen
- + Use 0.5-2.0 µl sample droplets
- + Ideal for DNA/RNA and Protein analysis
- + Cuvette port for OD600 readings (bacteria concentration)

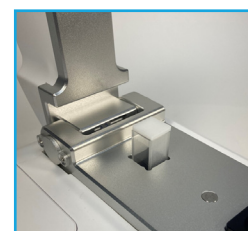
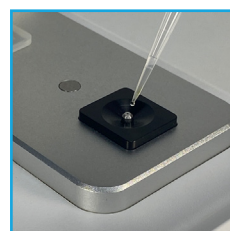

Accuris SmartDrop™ nano spectrophotometers are compact and easy-to-use instruments for quick and accurate readings using small volumes of sample. A droplet of sample is placed onto the sensor pedestal, the SmartDrop arm is lowered, and results are immediately displayed, saved, or printed using the on-board printer.

User-friendly software and an intuitive interface allows for quick set-up and determination of nucleic acid concentration (260nm absorbance) and purity (260/280nm ratio). In addition to common nucleic acid applications, the SmartDrop™ can also be used for determining protein purity using 280nm absorbance results. The SmartDrop models X and XF both have full wavelength 200-800nm scan capability within 6 seconds. The XF models includes fluorescence detection for accurate quantification of concentrations of nucleic acids, down to 0.5pg/ul.

A separate cuvette port for 600nm absorption readings is built into each instrument, expanding the usage of the SmartDrop™ for bacteria concentration evaluation and growth assays.

Results and data can be stored and organized in the onboard file memory or transferred via a USB drive to a PC for storage or further analysis. The built-in thermal printer is a unique feature to allow results to be printed immediately after analysis for adding to a lab notebook.

Ordering Information:

| Item No. | Description: |
|----------|--------------------------------------|
| NS1000* | SmartDrop™ L Nano Spectrophotometer |
| NS1010* | SmartDrop™ X Nano Spectrophotometer |
| NS1020* | SmartDrop™ XF Nano Spectrophotometer |

*115V with US plug. For 230V (EU plug), add (-E).

Technical Data:

| | NS1000 (L) | NS1010 (X) | NS1020 (XF) |
|------------------------------|---------------------------------------|---|---------------------------------------|
| Wavelength: | 260, 280, 600nm | 260-280nm | 260-280nm |
| Sample Size: | 1µl to 2.0µl | 0.5µl to 2.0µl | 0.5µl to 2.0µl |
| Path Length: | 0.5mm | 0.2mm & 1.0mm | 0.5mm, 0.2mm & 1.0mm |
| Measurement Time: | <8 sec. | <5 sec. | <6 sec. |
| Wavelength Accuracy: | 1nm | 1nm | 1nm |
| Absorbance Resproducibility: | 0.005Abs | 0.003Abs | 0.003Abs |
| Absorbance Accuracy: | 1% (7.332Abs at 260nm) | 1% (7.332Abs at 260nm) | 1% (7.332Abs at 260nm) |
| Optical Detector: | UV Silicon Photocell | 2048-Linear CCD array | 2048-Linear CCD array |
| Light Source: | LED | Xenon Lamp | Xenon Lamp |
| Detection Range dsDNA: | 10-4000ng/µl | 2-5000ng/µl | 2-15000ng/µl |
| Printer: | Built in printer | Built in printer | Built in printer |
| Cuvette OD 600nm | | | |
| Light Source: | LED | LED | LED |
| Absorbance Range: | 0-4A | 0-4A | 0-4A |
| Wavelength: | 600 +/- 8nm | 600 +/- 8nm | 600 +/- 8nm |
| Dimensions: | 8.3 x 11 x 7.1 in. 21 x 28 x 18 cm | 8.3 x 10.5 x 7 in. 21 x 26.8 x 18 cm | 8.3 x 11.8 x 7 in. 21 x 30 x 18 cm |
| Weight: | 7.7 lbs. (3.5kg) | 6.2 lbs. (2.8kg) | 6.2 lbs. (2.8kg) |
| Warranty: | 2 years | 2 years | 2 years |

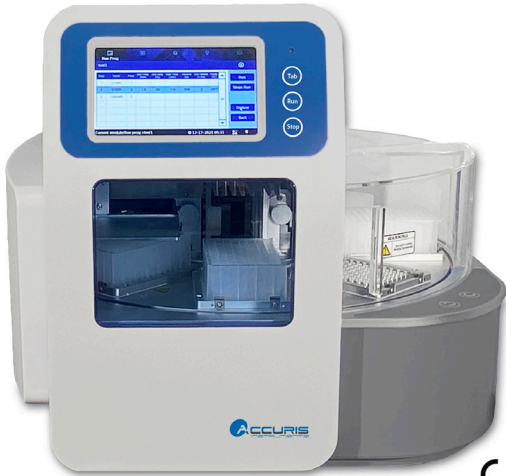

- + Operates as a stand-alone system, or connect to PC for programming
- + 8-position carousel for deep well sample plates
- + Intuitive programming and operation on a user-friendly touch screen
- + Reliable and automated processing of up to 96 samples

The IsoPure™ 96 from Accuris Instruments is a high throughput automated purification system that improves efficiency and reproducibility of magnetic bead extractions. Capable of processing up to 96 samples at one time, the instrument is easy to set up and program. Mixing, magnetic bead transfer, washing and elution steps are performed automatically, saving valuable hands-on time. The complete purification process can be finished in as little as 10 minutes (depending on the reagent kit and complexity of the program.)

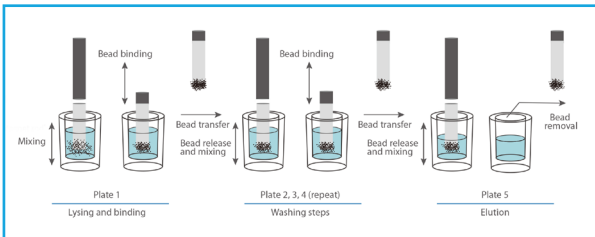

IsoPure™ Mini Purification System



- + Compact design takes up only 8 x 10 in. of bench space
- + Intuitive programming on a user-friendly touch screen
- + Higher yields and reproducibility than manual extraction methods
- + Fast and reliable sample processing

The IsoPure™ Mini from Accuris Instruments is an extremely compact, automated purification system that improves efficiency and reproducibility of magnetic bead extractions. Capable of processing up to 16 samples at one time, the instrument is easy to set up and program. Mixing, magnetic bead transfer, washing and elution steps are performed automatically, saving valuable hands-on time. The complete purification process can be finished in as little as 10 minutes (depending on the reagent kit and complexity of the program.)

Ordering Information:

| Item No. | Description: |
|---------------|---|
| AP1096* | IsoPure™ 96, Automated Purification Instrument |
| AP1096-DWP | 96 deep well plates |
| AP1096-TC | Tip Comb for SmartPure™ 96 |
| AP-1016* | IsoPure™ Mini, Automated Purification Instrument |
| AP1016-8W-100 | 8-well reagent vessel, 100/pk. |
| AP1016-MC-50 | 8 place magnet tip comb 50/pk. |

*115V with US plug. For 230V (EU plug), add (-E).

| Technical Data: | IsoPure™ Mini | IsoPure™ 96 |
|------------------------------|---|--|
| Capacity / Sample Volume: | 16 samples / 20µl to 1000µl | 96 samples / 20µl to 1000µl |
| Magnetic Bead recovery rate: | >95% | |
| Lysis Temperature range: | RT to 120°C | |
| Elution Temperature range: | RT to 120°C | |
| Display: | 4.3 inch color screen | 7.0 inch color screen |
| Programming Control: | Bluetooth, Android tablet | Touch screen/mouse, or PC connection |
| Program Memory: | 100 programs | |
| Communication: | USB | |
| Internal Lighting: | LED | |
| Contamination Control: | UV Sterilization | |
| Electrical Input: | Universal 120 to 240V, 50 to 60Hz | |
| Dimensions: (W x D x H) | 7.9 x 10.2 x 11.8 in. (20 x 26 x 30 cm) | 22 x 24.5 x 19.7 in. (56 x 62 x 50 cm) |
| Weight: | lbs. (kg) | lbs. (kg) |
| Warranty: | 2 years | |

SmartCheck™ DNA Ladders



- + Three size ranges: 50bp, 100bp and 1kb
- + Ready to use formulation includes loading buffer and tracking dye
- + Higher intensity reference bands
- + Concentration of 1µg/µl - load 5µl/lane
- + Ultra pure production allows for economical ambient shipping

Ordering Information:

| Item No. | Description: |
|------------|--|
| PR4005-100 | SmartCheck™ 50bp ladder, 500µl, 100 lanes |
| PR4005-500 | SmartCheck™ 50bp ladder, 5x500µl, 500 lanes |
| PR4010-100 | SmartCheck™ 100bp ladder, 500µl, 100 lanes |
| PR4010-500 | SmartCheck™ 100bp ladder, 5x500µl, 500 lanes |
| PR4100-100 | SmartCheck™ 1kb ladder, 500µl, 100 lanes |
| PR4100-500 | SmartCheck™ 1kb ladder, 5x500µl, 500 lanes |

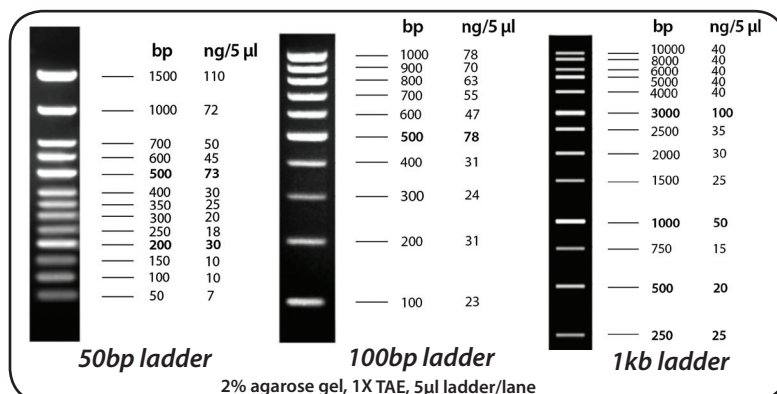

SmartCheck™ Protein Markers

Ordering Information:

| Item No. | Description: |
|-----------|---|
| PR5010-BL | SmartCheck™ Blue Protein Marker, 10 bands 9-180 kDa, 2x250ul |
| PR5011-BL | SmartCheck™ Blue Protein Marker, 11 bands 9-180 kDa, 2x250ul |
| PR5010-TC | SmartCheck™ Tri-color Protein Marker, 10 bands 9-180 kDa, 2x250ul |
| PR5012-TC | SmartCheck™ Tri-color Extended Range Protein Marker, 12 bands 9-245 kDa, 2x250ul |
| PR5013-TC | SmartCheck™ Tri-color Extended Range Plus Protein Marker, 13 bands 9-245 kDa, 2x250ul |

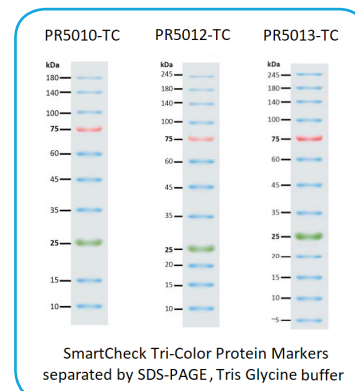

Convenient, premeasured packs



Just add pouch contents to water and stir to dissolve

QuickSilver™ Powdered Buffers

- + Premeasured pouches with quick dissolving powder
- + Makes 1L of ready to use 1X solution
- + No pH adjustment needed
- + Economical shipping with long shelf life
- + Guaranteed quality and consistency batch to batch

Ordering Information:

| Item No. | Description: |
|----------|---|
| EB1000 | TAE Buffer Powder, each pouch makes 1L of 1X, 100 pouches |
| EB1001 | TBE Buffer Powder, each pouch makes 1L of 1X, 50 pouches |
| EB1100 | Tris-Glycine-SDS Buffer Powder, each pouch makes 1L of 1X, 50 pouches |
| EB1200 | PBS Buffer Powder, each pouch makes 1L of 1X, 100 pouches |
| EB1201 | PBS-T Buffer Powder, each pouch makes 1L of 1X, 100 pouches |
| EB1202 | TBS Buffer Powder, each pouch makes 1L of 1X, 100 pouches |
| EB1203 | TBS-T Buffer Powder, each pouch makes 1L of 1X, 100 pouches |

MYGEL™ mini



- + Complete system
(Includes gel tank, power supply & casting accessories)
- + Quick and easy gel casting
(No spacers or clamps required)
- + Compact design, 7.5 x 5 in. footprint

The Accuris myGel Mini Electrophoresis System includes all the equipment you need to get up and running - gel tank, power supply and 2 complete casting sets. Ideal for personal use, small laboratories, or the classroom, this gel box/power supply combination is compact and easy to use.

The myGel Mini power supply attaches directly to the gel box for a secure connection every time. Selectable parameters include 3 preset voltages - 35, 50 and 100V - and a 99 minute timer. Parameters are set using the membrane keypad. The safety lid is vented to dissipate heat generated during electrophoresis, and features a viewing area above the gel. Current will only run through the system when the lid is properly in place on top of the gel box.

Trays and casting stands for both 10.5 x 6 cm and 5 x 6 cm gels are included with the myGel Mini system, as are double sided combs. The smaller tooth combs are compatible with multichannel pipettes. An optional casting set is available for 10.5 x 10cm gels. Casting is quick and easy - just place the tray in the casting stand and pour. The gel trays feature a dark contrast strip to help visualize wells while loading, and lines that fluoresce under UV and blue light to track the progress of the run.

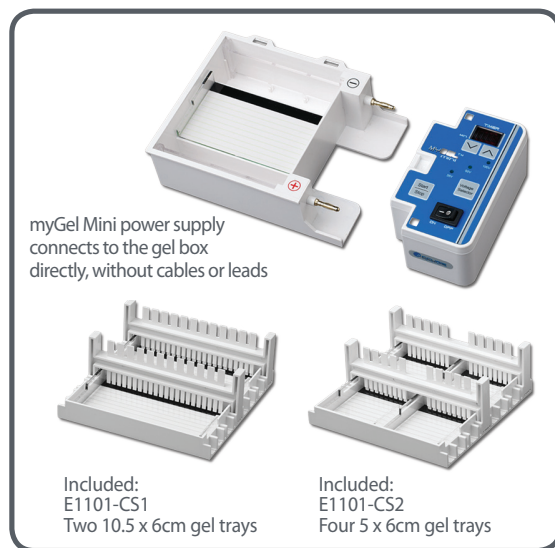

Comb Dimensions (E1101-COMB1)

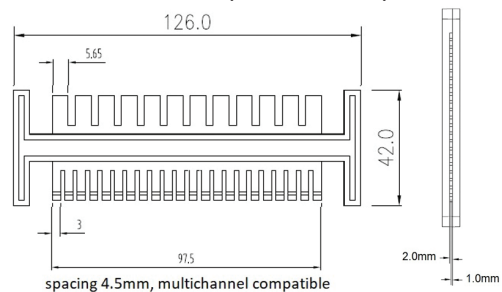

Large teeth: 5.65x1mm, well volume 22.6µl for 0.5mm thick gel
Small teeth: 3x1mm, well volume 12µl for 0.5cm thick gel
3mm wide teeth taper from 2mm to 1mm at tip

Ordering Information:

| Item No. | Description: |
|---|---|
| E1101* | MyGel™ Mini Electrophoresis System, complete with E1101-CS1 and E1101-CS2, 115V |
| myGel Mini includes all of the below casting accessories: | |
| E1101-CS1 | Extra casting set, for 10.5 x 6cm gels, includes two trays and two combs (22*/12 teeth) |
| E1101-COMB1 | Extra double sided combs, 22*/12 teeth, for E1101-CS1 and E1200-CS1 casting sets, pk 2 (multi-channel compatible) |
| E1101-CS2 | Extra casting set, for 5 x 6cm gels, includes four trays and two combs (18*/10 teeth) |
| E1101-COMB2 | Extra double sided combs, 18*/10 teeth, for E1101-CS2 casting set, pk 2 (multi-channel compatible) |
| Additional casting set available: | |
| E1200-CS1 | Casting set for 10.5 x 10cm gels, includes one tray and 2 combs (22*/12 teeth) |

*Multi-channel compatible

*115V with US plug. For 230V (EU plug and step down transformer), add (-E).

Technical Data:

| | |
|----------------------------|---|
| Output Voltage: | 35V, 50V or 100V |
| Timer: | 0-99 minute or continuous |
| Safety: | Magnetic and mechanical lid interlock |
| Max. Buffer Volume: | 230 ml |
| Gel Capacity: | One 10.5 x 6cm, one 10.5x10cm or two 5 x 6cm |
| Dimensions: (W x D x H) | 7.5 x 5.1 x 2.1 in. 19 x 13 x 5.5 cm |
| Weight: | 1 lbs (.45kg) |
| Electrical: | 115V, 60Hz or 230V, 50Hz |
| Warranty: | 2 years |

myGel™ Mini InstaView™ Electrophoresis System

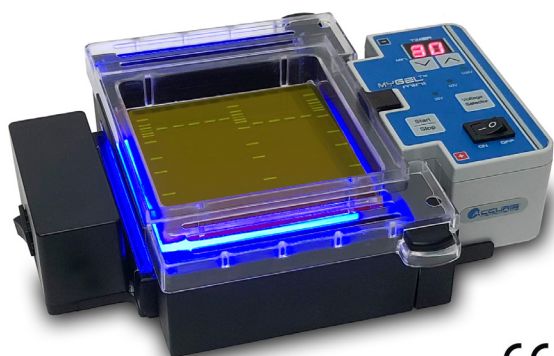

- + Complete system to run, visualize *and* document mini gels
- + Includes direct connect power supply, gel tank w/orange filter cover, casting set, blue light LED illuminator and smart phone imaging enclosure
- + View DNA migration and separation at any time during a run
- + Capture high resolution smart phone images without removing the gel from the tank

The new Accuris myGel Mini InstaView Electrophoresis System is a revolutionary product that allows viewing DNA separation as it happens. No longer is it necessary to stop your electrophoresis, remove the gel, and place it on a transilluminator to check the progress of the run.

The system's gel running tank is designed with a clear bottom and shaped to mate with the included LED transilluminator. The transilluminator's bright 465nm wavelength provides optimal excitation for common green fluorescent DNA stains (such as Accuris SmartGlow™, SYBR™ Green, Gel Green, and many others). The safety cover with orange viewing filter fits onto the top of the tank, and the recessed filter contacts the top surface of the buffer. This eliminates the possibility of fogging, and allows clear visualization of stained DNA as it migrates and separates. Results can be documented with a smart phone camera using the included imaging enclosure.

Ordering Information:

| Item No. | Description: |
|-------------|---|
| E1201* | MyGel™ Mini InstaView™ Electrophoresis System, complete with gel tank, power supply, E1200-CS1 casting set, blue LED transilluminator and imaging enclosure, 115V |
| E1200-CS1 | Extra casting set, for 10.5x10cm gels, includes casting stand, gel tray and 2 double sided combs, (22*/12 teeth) |
| E1101-COMB1 | Extra double sided combs, 22*/12 teeth, pack of 2 |

*Multi-channel compatible
*115V with US plug. For 230V (EU plug and step down transformer), add (-E).

Technical Data:

| | |
|--|--------------------------------|
| Output Voltage: | 35V, 50V or 100V |
| Timer: | 0-99 minute or continuous |
| Safety: | Magnetic switch |
| Max. Buffer Volume: | 250 ml |
| Gel Capacity: | One 10.5x10cm gel, 0.5cm thick |
| Excitation Wavelength: | 465nm |
| Dimensions with Enclosure: (W x D x H) | 10x8.25x5.5 in/25.5x21x14cm |
| Weight: | 2.3 lbs (1.04kg) |
| Electrical: | 115V, 60Hz or 230V, 50Hz |
| Warranty: | 2 years |

InstaView™ Gel Tank

- + View sample migration *during* electrophoresis
- + Includes gel tank, blue LED transilluminator, orange filter cover and imaging enclosure
- + Capture high resolution smart phone images without removing the gel from the tank
- + Compatible with any basic power supply



E2301

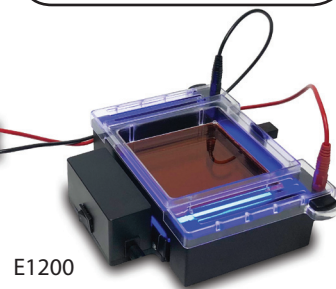
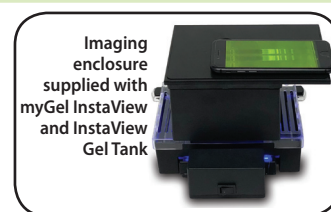

E1200

Ordering Information:

| Item No. | Description: |
|-------------|---|
| E1200* | InstaView™ Gel Tank, complete with tank, 10.5x10cm gel tray and casting set, 2 double sided combs (22*/12 teeth,) orange filter, blue LED transilluminator and imaging enclosure (7.25x8.25x5.5 in/18.4x21x14cm with imaging enclosure), 115V |
| E2301* | myVolt™ Touch Power Supply, 1 to 300V, 400mA, 100W |
| E1200-CS1 | Extra casting set, for 10.5x10cm gels, includes casting stand, gel tray and 2 double sided combs, (22*/12 teeth) |
| E1101-COMB1 | Extra double sided combs, 22*/12 teeth, pack of 2 |
| E1200-OC | Orange filter cover for mini LED transilluminator |

*Multi-channel compatible
*115V with US plug. For 230V add (-E).

UV TRANSILLUMINATORS

For Viewing DNA and Protein in Electrophoresis Gels



E3000

E3100

- + 302nm midrange UV wavelength
- + Optimal for EtBr, SmartGlow, or SYBR
- + Dual intensity settings, (50% or 100%) (E3000 model)
- + Hinged UV safety cover
- + Use with SmartDoc™ enclosure for gel imaging with a smart phone (pg. 87)



Optional viewing glasses

The **E3100 myView™** incorporates four 6W bulbs coupled with a reflector system and special diffusing filter glass to provide exceptional uniformity across the viewing surface. This allows for quantification of DNA and also higher quality imaging when using a camera system.

Users are protected from harmful effects of UV radiation by the hinged, UV blocking safety cover. Two friction hinges on the front edge of the cover allow for easy adjustment of the cover angle. Position the cover horizontally for general viewing, tilt it at an angle for gel access and band cutting, or fully open to use the SmartDoc™ Imaging Enclosure and filters (sold separately) for gel imaging with a smartphone. Use filter E5001-UVBLOCK for best results when imaging SmartGlow, SYBR or ETBR stained gels.

The E3100 myView™ Transilluminator has a surprisingly small footprint (smaller than a standard piece of paper). However, the viewing surface is large enough to accommodate a mid-sized gel or multiple smaller gels. The 16.5 x 13.5 cm filter glass is scratch resistant to allow band excision with a metal blade.

The **Accuris™ E3000 UV Transilluminator** features a space-saving design, with a width of only 10.5 inches, to fit perfectly in any busy laboratory. However, the 16 x 19 cm UV viewing surface is sized to accommodate large gels or multiple smaller gels. The illuminated surface is comprised of a special black glass which is easy to clean, durable and scratch resistant.

An array of high intensity UV bulbs coupled with an optimized filter provides even illumination across the viewing surface and allows detection of small sample quantities. The dual intensity switch can be used to lower the UV intensity to 50% to reduce DNA damage during long exposure times, or switch to high intensity (100%) for viewing weak fluorescent signals or for photo documentation.

The acrylic UV blocking cover allows safe viewing of samples and has two friction hinges on the front edge to allow angling of the cover for gel access. The cover can be positioned to 90° - straight up - to fit a gel imaging hood, such as the Accuris SmartDoc™ imaging enclosure.

Ordering Information:

| Item No. | Description: |
|---------------|--|
| E3100* | Accuris™ Compact UV Transilluminator |
| E3000* | Accuris™ UV Transilluminator |
| E5001-SD | SmartDoc™ Imaging Enclosure with orange photo filter |
| E5001-535 | SmartDoc photo filter, 535nm for imaging green stains on UV |
| E5001-590 | SmartDoc photo filter, 590nm for imaging EtBr on UV |
| E5001-UVBLOCK | SmartDoc filter, blocks UV wavelength, optimized for use on E3100 transilluminator |
| E4000-VG1 | SmartBlue Plus Viewing Glasses |

*115V with US plug. For 230V (EU plug), add (-E).

| Technical Data: | E3100 | E3000 |
|-------------------------|------------------------------------|---|
| Light Source: | 4 x 6 Watt UV bulbs | 4 x 8 Watt UV bulbs |
| Wavelength: | 302nm | |
| Intensity Control: | N/A | Low (50%) or High (100%) |
| Viewing Surface: | 16.5 x 13.5 cm | 16 x 19 cm |
| Dimensions: (W x D x H) | 10 x 8 x 2.75 in. / 25 x 20 x 7 cm | 10.5 x 13 x 5.5 in. / 26.5 x 32.5 x 14 cm |
| Weight: | 2 lbs. (0.9kg) | 12 lbs. (5.5kg) |
| Electrical: | 115V or 230V, 50Hz to 60Hz | |
| Warranty: | 2 years | |

SMARTBLUE™

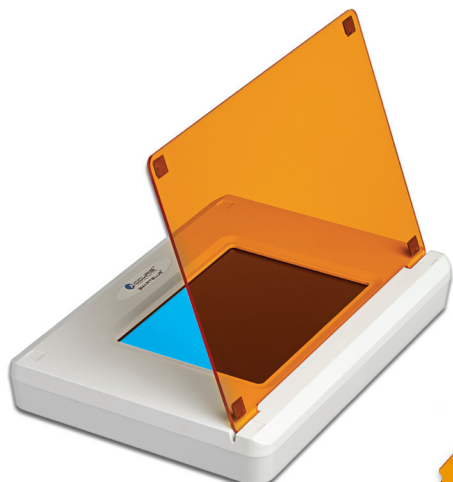

CE E4100

- + Safe blue light does not damage nucleic acid
- + Uniform Illumination (UI) provides even lighting
- + 465nm wavelength, optimal for green stains
- + Two position amber cover is also removable

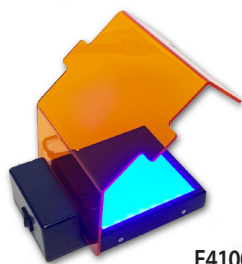

E4100

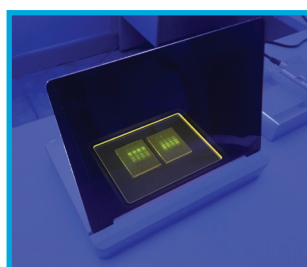

Markers stained with SmartGlow™ shown on SmartBlue



Optional viewing glasses

Safer for samples, safer for you: Accuris SmartBlue Transilluminators are the perfect partner for the most common safe DNA stains. These instruments emit blue light at a wavelength of 465nm, perfect for excitation of most green fluorophors, including our Accuris' SmartGlow™, SYBR Green, SYBR Safe, SYBR Gold, GelStar, GelGreen, to name a few. The SmartBlue can also works for excitation of EtBr (though fluorescence is not as bright as with UV), see our Technical Bulletin with sample images. Exposing DNA to blue wavelength does not cause molecular damage, and results in a much higher downstream cloning efficiency as compared to even short UV light exposures. In addition, the visible blue light is not damaging to the user's skin and is less harmful to the eyes.* Two position filter cover: Both the E4100 and E4000 transilluminators come with emission filter covers. These amber covers, which rest above the viewing surface and gel, filter out the blue light, allowing the fluorescinc DNA bands to be seen clearly. The covers are designed to fit flat for general gel viewing or to be placed at an angle to provide easy access to the gel for band excision. For documentation, the filter cover is easily removed completely.

Optional amber viewing glasses: Our E4000-VG1 SmartBlue Plus Viewing Glasses offer efficient blocking of the blue light wavelength from the transilluminators, allowing clear visualization of the fluorescing DNA bands without the filter cover in place. These convenient glasses are recommended for users that are frequently excising DNA bands from gels. SmartBlue Plus glasses also block 100% of UV wavelength so they can also be used for viewing gels on a UV transilluminator.

* The SmartBlue products use high intensity LED lights. Although the visible blue wavelength is significantly safer than UV light, it is recommended to not stare directly at the viewing surface without the amber cover in place.

| Technical Data: | E4000 | E4100 |
|-------------------------|--|---------------------------------------|
| Light Source: | High Intensity Blue LEDs | |
| Wavelength: | Peak at 465nm | |
| Viewing Surface: | 17 x 12 cm | 10.5 x 10.5 cm |
| Viewing Surface: | Amber, filters blue light | |
| Dimensions: (W x D x H) | 12.8 x 8.5 x 1.9 in. / 30.5 x 21.5 x 5 cm | 6.7 x 4.72 x 2 in. / 7 x 12 x 5 cm |
| Weight: | 2.6 lbs. (1.2kg) | |
| Electrical: | 115V or 230V, 50Hz to 60Hz | |
| Warranty: | 2 years | |

Ordering Information:

| Item No. | Description: |
|-----------|---|
| E4000* | SmartBlue™ Blue Light Transilluminator |
| E4100* | SmartBlue™ Mini Blue Light Transilluminator, includes amber cover |
| E5001-SD | SmartDoc™ Imaging Enclosure with orange photo filter |
| E4000-VG1 | Orange viewing glasses for use with blue light, includes case |

*115V with US plug. For 230V (EU plug), add (-E).



CE

E5001-SDB

SMARTDOC™ 2.0

Gel Visualization and Smart Phone Imaging System

- + Quality imaging with any smart phone
- + Ideal for common safe stains (SmartGlow™, SYBR® Green, Gel Green, etc.)
- + Visible blue light will not damage DNA
- + Gel access for DNA band cutting
- + Imaging enclosure available individually and can be used on existing transilluminators

Technical Data:

| | |
|-------------------------|--|
| Maximum gel size: | 15 x 15cm |
| Excitation source: | High intensity blue LED |
| Photo filter: | Orange PMMA, 12mm aperture |
| Viewing cover: | Orange PMMA, 18cm x 18cm |
| Phone compatibility: | iPhone™, Android™, etc. (smart phones and tablets with a camera) |
| Dimensions (W x D x H): | 9 x 7.5 x 8.6 in. / 23 x 19 x 22 cm |
| Weight: | 2.6 lbs (1.2kg) |
| Electrical: | 115V or 230V, 50Hz to 60Hz |
| Warranty: | 2 years |

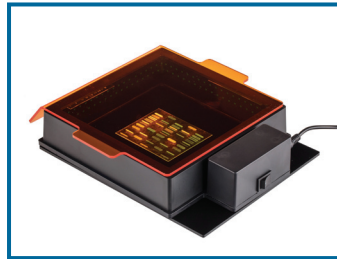

Standalone blue light illumination base (Included with E5001-SDB)

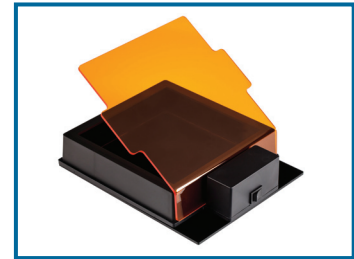

Included orange cover can be tilted for gel access

Ordering Information:

| Item No. | Description: |
|------------|--|
| E5001-SDB* | SmartDoc™ Gel Imaging System with blue light illumination and orange photo filter |
| E5001-SD | SmartDoc™ Gel Imaging Enclosure (use on existing transilluminator) w/orange photo filter |
| E5000-MAT | UV Blocking Mat |
| E5001-535 | SmartDoc photo filter, 535nm for imaging green stains on UV |
| E5001-590 | SmartDoc photo filter, 590nm for imaging EtBr on UV |
| E4000-VG1 | Orange viewing glasses for use with blue light, includes case |

*Includes US plug. For EU plug, please add (-E).



E5001-SD Enclosure shown on E4000 UV Transilluminator

SmartGlow™ Safe Nucleic Acid Stain

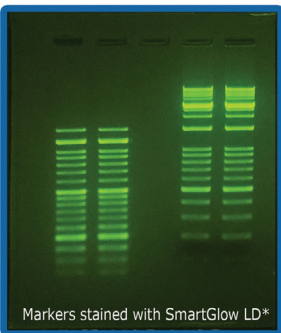

Markers stained with SmartGlow LD*
*Excitation with Accuris SmartBlue™ Transilluminator. Imaged using Accuris SmartDoc™ Blue with iPhone®.

- + Replaces hazardous EtBr
- + Excitation by UV or blue light
- + Non-mutagenic, environmentally safe
- + Two types: PS (Pre-Stain) LD (loading Dye)

Ordering Information:

| Item No. | Description: |
|----------|--|
| E4500-PS | SmartGlow™ PS (Pre-Stain), 1ml (20,000X) |
| E4500-LD | SmartGlow™ LD (Loading Dye) with stain, 1ml (6X) |



CE

Ordering Information:

| Item No. | Description: |
|----------|--|
| E2100* | myVolt™ Mini Power Supply, 100V / 200V |

*Includes US plug. For EU plug, please add (-E).

- + Ideal for basic electrophoresis and compatible with standard electrophoresis gel tanks
- + Compact and simple with 100V or 200V output
- + Two pairs of output terminals

Technical Data:

| | |
|-------------------|---|
| Voltage Output: | 100V or 200V constant |
| Current Output: | Max. 200mA |
| Max Wattage: | 40W |
| Output Terminals: | 2 pairs (wired in parallel) |
| Dimensions: | 6.25 x 4.5 x 2.25in. / 16 x 11.5 x 5.7 cm |
| Weight: | 0.9lbs (0.4kg) |
| Electrical: | 100 - 240V, 50 - 60Hz |
| Warranty: | 2 years |

myVolt™ Touch Power Supply



CE



Dual Orientation, Auto-Rotating Display

- + Touchscreen control
- + Dual orientation, auto-rotating display (fits anywhere in a crowded lab)
- + Intuitive programming
- + Control voltage, amperage, and run time

The Accuris myVolt Touch is a work horse electrophoresis power supply that includes all of the performance and specifications needed for efficient separation of nucleic acids and proteins. The perfect companion for both horizontal and mini vertical gel tanks, the myVolt Touch incorporates some very unique user-friendly features:

Touch-screen Control Panel: Setting up an electrophoresis run with the myVolt Touch couldn't be easier... adjust voltage, current and time values, then touch "Start" to begin the run. Voltage, current and run time are all displayed.

Technical Data:

| | |
|----------------------|--|
| Output Settings: | Constant voltage or constant current |
| Voltage Output: | 10 - 300V (5V increments) |
| Current Output: | 5 - 400mA (5mA increments) |
| Max Wattage: | 100W |
| Timer: | 1 min. to 20 hours or continuous |
| Output Terminals: | 4 pairs (wired in parallel) |
| Safety: | No load, short circuit, overload detection, over power detection |
| Display: (W x D x H) | 2 x 2in. touchscreen LCD |
| Dimensions: | 8.5 x 6.3 x 4.0in. / 21.5 x 15.5 x 9.75 cm |
| Weight: | 2lbs (0.9kg) |
| Electrical: | 115V, 60Hz or 230V, 50Hz |
| Warranty: | 2 years |

Dual Orientation, Auto-Rotating Display: The myVolt Touch packs plenty of power and features into a compact housing. But for those crowded lab benches, we've taken our design a step further. The myVolt can be oriented horizontally or vertically to fit the space available either on the lab bench or a shelf. When the power supply is tilted up vertically or back down horizontally, the display automatically rotates. Folding feet can be extended when the power supply is horizontal for convenient access and viewing of the touch screen. When set vertically, the touchscreen is also tilted up toward the user.

Ordering Information:

| Item No. | Description: |
|----------|--|
| E2301* | myVolt™ Touch Power Supply, 1 to 300V max, 400mA, 100W |

*115V with US plug. For 230V (EU plug), please add (-E).

Accuris™ Taq DNA Polymerase and Master Mix



- For routine PCR, genotyping, colony PCR and fast PCR
- Proprietary buffer optimized for a variety of assay conditions
- Supplied with separate 5x buffer or as a convenient master mix

| Item No. | Description | Size |
|---------------|-----------------------|-----------------------|
| PR1000-500 | Taq DNA Polymerase | 500u (5u/μl) |
| PR1000-1000 | Taq DNA Polymerase | 1000u (5u/μl) |
| PR1000-6000 | Taq DNA Polymerase | 6000u (5u/μl) |
| PR1001-200 | 2x Taq Master Mix | 200 x 50μl Reactions |
| PR1001-1000 | 2x Taq Master Mix | 1000 x 50μl Reactions |
| PR1001-R-200 | 2x Taq Red Master Mix | 200 x 50μl Reactions |
| PR1001-R-1000 | 2x Taq Red Master Mix | 1000 x 50μl Reactions |

Red Master Mix includes a loading dye for direct electrophoresis after PCR

Accuris™ Hot Start Taq DNA Polymerase and Master Mix



- Exceptional sensitivity for low copy PCR
- Ideal for multiplex PCR & amplification of GC-rich DNA
- Same enhanced features as Accuris Taq Polymerase
- Optimized for fast cycling and reproducibility

| Item No. | Description | Size |
|-----------------|---------------------------------|------------------|
| PR1000-HS-500 | Hot Start Taq DNA Polymerase | 500u (5u/μl) |
| PR1000-HS-1000 | Hot Start Taq DNA Polymerase | 1000u (5u/μl) |
| PR1000-HS-6000 | Hot Start Taq DNA Polymerase | 6000u (5u/μl) |
| PR1001-HS-200 | Hot Start 2x Taq Master Mix | 200 x 50μl Rxns |
| PR1001-HS-1000 | Hot Start 2x Taq Master Mix | 1000 x 50μl Rxns |
| PR1001-HSR-200 | Hot Start 2x Taq Red Master Mix | 200 x 50μl Rxns |
| PR1001-HSR-1000 | Hot Start 2x Taq Red Master Mix | 1000 x 50μl Rxns |

Red Master Mix includes a loading dye for direct electrophoresis after PCR

Accuris™ Taq Plus DNA Polymerase & Master Mix



- Higher fidelity for long PCR amplicons, up to 35kb
- Ideal for problematic templates and TA cloning
- Better sensitivity and higher activity for low copy and long PCR

| Item No. | Description | Volume |
|----------------|-------------------------|-----------------------|
| PR1000-TP-250 | Taq Plus DNA Polymerase | 250u (5u/μl) |
| PR1000-TP-500 | Taq Plus DNA Polymerase | 1000u (5u/μl) |
| PR1001-TP-200 | 2x Taq Plus Master Mix | 200 x 50μl Reactions |
| PR1001-TP-1000 | 2x Taq Plus Master Mix | 1000 x 50μl Reactions |

Accuris™ High Fidelity DNA Polymerase



- 50X higher fidelity than Taq polymerase
- Works with crude DNA samples
- Ideal for cloning, mutagenesis & microarrays
- Leaves a blunt end

| Item No. | Description | Size |
|----------------|------------------------------|---------------|
| PR1000-HF-200 | High Fidelity DNA Polymerase | 200u (2u/μl) |
| PR1000-HF-1000 | High Fidelity DNA Polymerase | 1000u (2u/μl) |

Accuris™ High Fidelity Master Mix



- 100X fidelity of native Taq
- Leaves blunt ends

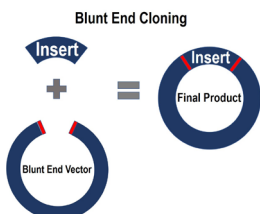

| Item No. | Description | Size |
|---------------|--------------------------|-----------------|
| PR1001-HF-200 | High Fidelity Master Mix | 200 x 25μl rxns |
| PR1001-HF-500 | High Fidelity Master Mix | 500 x 25μl rxns |

Accuris™ High Fidelity Hot Start Master Mix



- 10X fidelity of native Taq
- Leaves A overhang

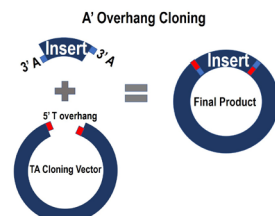

| Item No. | Description | Size |
|----------------|------------------------------|-----------------|
| PR1000-HF-200 | High Fidelity DNA Polymerase | 200 x 25μl rxns |
| PR1000-HF-1000 | High Fidelity DNA Polymerase | 500 x 25μl rxns |

Accuris™ 1 Hour Mammalian Genotyping Kit



Accuris™ 1 Hour Mammalian Genotyping Kit
Includes Hot Start Taq Master Mix

- + DNA extraction and amplification in one hour
- + Proprietary lysis buffer optimized for ear punches, tail snips and other mammalian tissues
- + Single tube process - no organic solvents or clean up procedures

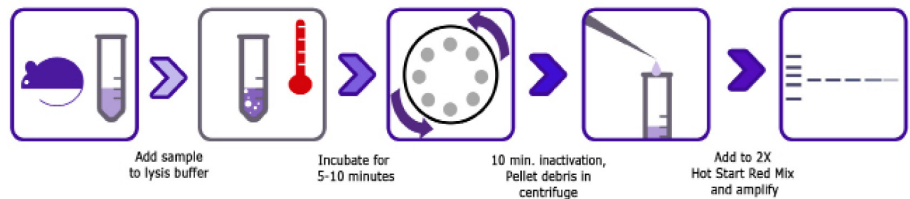

| Item No. | Description | Reactions |
|---------------|---|-----------|
| PR1300-MG-80 | Accuris 1 Hour Mammalian Genotyping Kit | 80 |
| PR1300-MG-400 | Accuris 1 Hour Mammalian Genotyping Kit | 400 |

qMAX™ Green Real Time PCR Mix

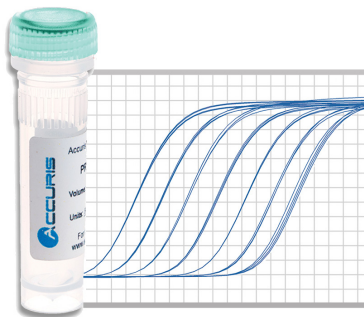

- + Superior sensitivity and fast cycling with exceptional results
- + Includes Accuris Hot Start Taq for greater specificity & accuracy
- + Early C_t values and detection across a broad dynamic range
- + Ideal for low copy number templates

| Item No. | Description | Reactions (20µl volume) |
|---------------|-------------------------------|-------------------------|
| PR2000-L-100 | qMAX Green, Low ROX qPCR Mix | 100 |
| PR2000-L-500 | qMAX Green, Low ROX qPCR Mix | 500 |
| PR2000-L-1000 | qMAX Green, Low ROX qPCR Mix | 1000 |
| PR2000-H-100 | qMAX Green, High ROX qPCR Mix | 100 |
| PR2000-H-500 | qMAX Green, High ROX qPCR Mix | 500 |
| PR2000-H-1000 | qMAX Green, High ROX qPCR Mix | 1000 |
| PR2000-N-100 | qMAX Green, No ROX qPCR Mix | 100 |
| PR2000-N-500 | qMAX Green, No ROX qPCR Mix | 500 |
| PR2000-N-1000 | qMAX Green, No ROX qPCR Mix | 1000 |

qMAX™ Probe Real Time PCR Mix

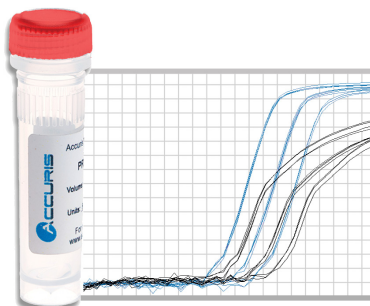

- + Same high efficiency for multiplex and singleplex reactions
- + Includes Accuris Hot Start Taq Polymerase for greater specificity and accuracy
- + Compatible with popular hydrolysis and beacon probes
- + Early C_t values and detection across a broad dynamic range

| Item No. | Description | Reactions (20µl volume) |
|---------------|-------------------------------|-------------------------|
| PR2001-L-100 | qMAX Probe, Low ROX qPCR Mix | 100 |
| PR2001-L-500 | qMAX Probe, Low ROX qPCR Mix | 500 |
| PR2001-L-1000 | qMAX Probe, Low ROX qPCR Mix | 1000 |
| PR2001-H-100 | qMAX Probe, High ROX qPCR Mix | 100 |
| PR2001-H-500 | qMAX Probe, High ROX qPCR Mix | 500 |
| PR2001-H-1000 | qMAX Probe, High ROX qPCR Mix | 1000 |
| PR2001-N-100 | qMAX Probe, No ROX qPCR Mix | 100 |
| PR2001-N-500 | qMAX Probe, No ROX qPCR Mix | 500 |
| PR2001-N-1000 | qMAX Probe, No ROX qPCR Mix | 1000 |

Please visit www.accuris-usa.com for additional details on the Accuris PCR Reagents

qMAX™ cDNA Synthesis Kit



- + Rapidly generate high quality qPCR ready cDNA
- + Thermostable qMax RT with RNase inhibitor
- + Optimized for use across a wide dynamic range
- + Two tube format for easy reaction set up
- + Blend of oligo (dT) and hexamer primers for unbiased, complete sequence representation

| Item No. | Description | Reactions (20µl volume) |
|--------------|-------------------------|-------------------------|
| PR2100-C-25 | qMAX cDNA Synthesis Kit | 25 |
| PR2100-C-100 | qMAX cDNA Synthesis Kit | 100 |
| PR2100-C-250 | qMAX cDNA Synthesis Kit | 250 |

qMAX™ First Strand cDNA Synthesis Flex Kit



- + Rapidly generate high quality qPCR ready cDNA
- + Thermostable qMax RT with RNase inhibitor
- + Optimized for use across a wide dynamic range
- + Separate tubes of oligo (dT) and hexamer primers for greater flexibility in assay design

| Item No. | Description | Reactions (20µl volume) |
|--------------|-------------------------|-------------------------|
| PR2110-C-50 | qMAX cDNA Synthesis Kit | 50 |
| PR2110-C-200 | qMAX cDNA Synthesis Kit | 200 |

Accuris™ One-Step Kits



Accuris™ One-Step RT-qPCR Mix
cDNA Synthesis and qPCR in a single tube

- + RNA to cDNA to qPCR, in one reaction tube
- + High purity enzyme formulation
- + Enhanced stability and performance
- + Incorporates Accuris Hot-Start Taq
- + Available for green fluorescence or probe detection
- + Multiplex formulation available for multiple target amplification

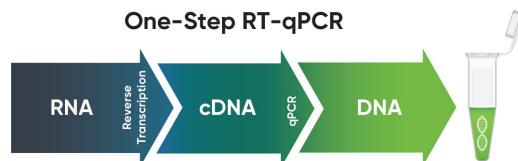

| Item No. | Description | Reactions (20µl volume) |
|--------------|--|-------------------------|
| PR2120-L-100 | qMAX Green, One-Step RT-qPCR Kit, Low Rox | 100 |
| PR2120-H-100 | qMAX Green, One-Step RT-qPCR Kit, High Rox | 100 |
| PR2121-L-100 | qMAX Probe, One-Step RT-qPCR Kit, Low Rox | 100 |
| PR2121-H-100 | qMAX Probe, One-Step RT-qPCR Kit, High Rox | 100 |
| PR2122-L-100 | qMAX Probe, One-Step Multiplex RT-qPCR Kit, Low Rox | 100 |
| PR2122-H-100 | qMAX Probe, One-Step Multiplex RT-qPCR Kit, High Rox | 100 |

Above items available in 500 and 1000 reaction pack size. Add "-500" or "-1000" to Item No.

Centrifuges ■ Shakers/Mixers ■ Homogenizers
Sterilizers ■ Temperature Control ■ Accuris Instruments

22-23



Benchmark 
Scientific

PO Box 709
Edison, NJ 08818
Phone: 908-769-5555
Fax: 732-313-7007

Email: Info@BenchmarkScientific.com

www.BenchmarkScientific.com